

This document must remain the original when submitted, no copies will be accepted

# MPUMALANGA PROVINCIAL GOVERNMENT



## DEPARTMENT OF AGRICULTURE, RURAL DEVELOPMENT, LAND AND ENVIRONMENTAL AFFAIRS

**BID NUMBER: ALA/607/26/MP**

### **RIVER ABSTRACTION PUMP STATION WITH WATER TREATMENT PLANT FOR INKANYEZI POULTRY FARM IN CALM, GERT SIBANDE DISTRICT**

ISSUED BY:

Department of Culture, Sports & Recreation  
Private Bag X11219  
Mbombela  
1200

**NAME OF BIDDER:** .....

**TOTAL BID PRICE (all inclusive) :**.....

**(Also in words):** .....

.....

## PART A INVITATION TO BID

|   |  |               |   |   |              |
|---|--|---------------|---|---|--------------|
| <b>YOU ARE HEREBY INVITED TO BID FOR REQUIREMENTS OF THE DEPARTMENT OF AGRICULTURE, RURAL DEVELOPMENT, LAND AND ENVIRONMENTAL AFFAIRS</b>   |  |               |   |   |              |
| BID NUMBER:   | <b>ALA/607/26/MP</b>   | CLOSING DATE: | <b>14 JULY 2026</b>   | CLOSING TIME:   | <b>12H00</b> |
| DESCRIPTION   | <b>RIVER ABSTRACTION PUMP STATION WITH WATER TREATMENT PLANT FOR INKANYEZI POULTRY FARM IN CALM, GERT SIBANDE DISTRICT</b>   |               |   |   |              |
| <b>BID RESPONSE DOCUMENTS MAY BE DEPOSITED IN THE BID BOX SITUATED AT (STREET ADDRESS)</b>  |  |               |   |   |              |
| <b>MBOMBELA</b> , Riverside Government Complex, Building No 9, Government Boulevard, Mbombela, 1200, <b>PIET RETIEF</b> , No. 11 Measroch Street, Piet Retief Office, <b>KWAMHLANGA</b> , KwaMhlanga Government Complex, Department of Finance, Building No. 12, Computer Centre <b>SECUNDA</b> No 5 Van Eck Street, Secunda (opposite Sasol Value Gas Garage) Secunda, 2280, <b>BUSHBUCKRIDGE</b> , Bushbuckridge Advice Centre, Department of Finance, Protea building (old Telkom building), <b>MIDDELBURG</b> , Department of Public Works, Cnr. Lillian Ngoyi and Dr Beyers Naudé Streets – Old TPA Building, Upper ground floor, Office numbers A20, 21 and 25, <b>MALELANE</b> , 24 Air Street, Malelane, <b>ELUKWATINI</b> , Elukwatini Sub Regional offices, Office numbers A49 and A50 (opposite Elukwatini Community Hall) Stand number 12 Extension A, Elukwatini 1192. <b>SIYABUSWA</b> Old Parliament Building, Building No.1, Job Skhosana Street, Siyabuswa 0472. |  |               |   |   |              |
| <b>BIDDING PROCEDURE ENQUIRIES MAY BE DIRECTED TO</b>   |  |               | <b>TECHNICAL ENQUIRIES MAY BE DIRECTED TO:</b>                    |   |              |
| CONTACT PERSON  | <b>Ms. NI Mbuyane / Ms. TV Dhludhlu</b>  |               | CONTACT PERSON  | <b>Ms. TA Memela / Eng J Jiyane (Pr Eng)</b>  |              |
| TELEPHONE NUMBER  | <b>013 766 6118 / 6674</b>   |               | TELEPHONE NUMBER  | <b>063 698 3253 / 071 689 6890</b>  |              |
| FACSIMILE NUMBER  |  |               | FACSIMILE NUMBER  |   |              |
| E-MAIL ADDRESS  | <a href="mailto:nimbuyane@mpg.gov.za">nimbuyane@mpg.gov.za</a><br><a href="mailto:vmanana@mpg.gov.za">vmanana@mpg.gov.za</a> |               | E-MAIL ADDRESS  | <a href="mailto:Thabie04@yahoo.co.za">Thabie04@yahoo.co.za</a> / <a href="mailto:jnijiyane@gmail.com">jnijiyane@gmail.com</a> |              |
| <b>SUPPLIER INFORMATION</b>   |  |               |   |   |              |
| NAME OF BIDDER  |  |               |   |   |              |
| POSTAL ADDRESS  |  |               |   |   |              |
| STREET ADDRESS  |  |               |   |   |              |
| TELEPHONE NUMBER  | CODE   |               | NUMBER  |   |              |
| CELLPHONE NUMBER  |  |               |   |   |              |
| FACSIMILE NUMBER  | CODE   |               | NUMBER  |   |              |
| E-MAIL ADDRESS  |  |               |   |   |              |
| VAT REGISTRATION NUMBER   |  |               |   |   |              |
| SUPPLIER COMPLIANCE STATUS  | TAX COMPLIANCE SYSTEM PIN:   |               | <b>OR</b>   | CENTRAL SUPPLIER DATABASE No:   | MAAA         |
| ARE YOU THE ACCREDITED REPRESENTATIVE IN SOUTH AFRICA FOR THE GOODS /SERVICES OFFERED?  | <input type="checkbox"/> Yes <input type="checkbox"/> No<br>[IF YES ENCLOSE PROOF]   |               | ARE YOU A FOREIGN BASED SUPPLIER FOR THE GOODS /SERVICES OFFERED? | <input type="checkbox"/> Yes <input type="checkbox"/> No<br>[IF YES, ANSWER THE QUESTIONNAIRE BELOW]                          |              |
| <b>QUESTIONNAIRE TO BIDDING FOREIGN SUPPLIERS</b>   |  |               |   |   |              |
| IS THE ENTITY A RESIDENT OF THE REPUBLIC OF SOUTH AFRICA (RSA)? <span style="float: right;"><input type="checkbox"/> YES <input type="checkbox"/> NO</span>   |  |               |   |   |              |
| DOES THE ENTITY HAVE A BRANCH IN THE RSA? <span style="float: right;"><input type="checkbox"/> YES <input type="checkbox"/> NO</span>   |  |               |   |   |              |
| DOES THE ENTITY HAVE A PERMANENT ESTABLISHMENT IN THE RSA? <span style="float: right;"><input type="checkbox"/> YES <input type="checkbox"/> NO</span>  |  |               |   |   |              |
| DOES THE ENTITY HAVE ANY SOURCE OF INCOME IN THE RSA? <span style="float: right;"><input type="checkbox"/> YES <input type="checkbox"/> NO</span>   |  |               |   |   |              |
| IS THE ENTITY LIABLE IN THE RSA FOR ANY FORM OF TAXATION? <span style="float: right;"><input type="checkbox"/> YES <input type="checkbox"/> NO</span>   |  |               |   |   |              |
| IF THE ANSWER IS "NO" TO ALL OF THE ABOVE, THEN IT IS NOT A REQUIREMENT TO REGISTER FOR A TAX COMPLIANCE STATUS SYSTEM PIN CODE FROM THE SOUTH AFRICAN REVENUE SERVICE (SARS) AND IF NOT REGISTER AS PER 2.3 BELOW.   |  |               |   |   |              |

**PART B  
TERMS AND CONDITIONS FOR BIDDING**

|  |
|--|
| <b>1. BID SUBMISSION:</b>  |
| 1.1. BIDS MUST BE DELIVERED BY THE STIPULATED TIME TO THE CORRECT ADDRESS. LATE BIDS WILL NOT BE ACCEPTED FOR CONSIDERATION.   |
| 1.2. <b>ALL BIDS MUST BE SUBMITTED ON THE OFFICIAL FORMS PROVIDED (NOT TO BE RE-TYPED) OR IN THE MANNER PRESCRIBED IN THE BID DOCUMENT.</b>  |
| 1.3. THIS BID IS SUBJECT TO THE PREFERENTIAL PROCUREMENT POLICY FRAMEWORK ACT, 2000 AND THE PREFERENTIAL PROCUREMENT REGULATIONS, THE GENERAL CONDITIONS OF CONTRACT (GCC) AND, IF APPLICABLE, ANY OTHER SPECIAL CONDITIONS OF CONTRACT. |
| 1.4. <b>THE SUCCESSFUL BIDDER WILL BE REQUIRED TO FILL IN AND SIGN A WRITTEN CONTRACT FORM (SBD7).</b>   |
| <b>2. TAX COMPLIANCE REQUIREMENTS</b>  |
| 2.1 BIDDERS MUST ENSURE COMPLIANCE WITH THEIR TAX OBLIGATIONS.   |
| 2.2 BIDDERS ARE REQUIRED TO SUBMIT THEIR UNIQUE PERSONAL IDENTIFICATION NUMBER (PIN) ISSUED BY SARS TO ENABLE THE ORGAN OF STATE TO VERIFY THE TAXPAYER'S PROFILE AND TAX STATUS.  |
| 2.3 APPLICATION FOR TAX COMPLIANCE STATUS (TCS) PIN MAY BE MADE VIA E-FILING THROUGH THE SARS WEBSITE WWW.SARS.GOV.ZA.   |
| 2.4 BIDDERS MAY ALSO SUBMIT A PRINTED TCS CERTIFICATE TOGETHER WITH THE BID.   |
| 2.5 IN BIDS WHERE CONSORTIA / JOINT VENTURES / SUB-CONTRACTORS ARE INVOLVED; EACH PARTY MUST SUBMIT A SEPARATE TCS CERTIFICATE / PIN / CSD NUMBER.   |
| 2.6 WHERE NO TCS PIN IS AVAILABLE BUT THE BIDDER IS REGISTERED ON THE CENTRAL SUPPLIER DATABASE (CSD), A CSD NUMBER MUST BE PROVIDED.  |
| 2.7 NO BIDS WILL BE CONSIDERED FROM PERSONS IN THE SERVICE OF THE STATE, COMPANIES WITH DIRECTORS WHO ARE PERSONS IN THE SERVICE OF THE STATE, OR CLOSE CORPORATIONS WITH MEMBERS PERSONS IN THE SERVICE OF THE STATE."                  |

**NB: FAILURE TO PROVIDE / OR COMPLY WITH ANY OF THE ABOVE PARTICULARS MAY RENDER THE BID INVALID.**

SIGNATURE OF BIDDER: .....

CAPACITY UNDER WHICH THIS BID IS SIGNED: .....  
(Proof of authority must be submitted e.g. company resolution)

DATE: .....

# MPUMALANGA PROVINCIAL GOVERNMENT



DEPARTMENT OF AGRICULTURE, RURAL DEVELOPMENT, LAND AND ENVIRONMENTAL  
AFFAIRS

## BID DOCUMENT

RIVER ABSTRACTION PUMP STATION WITH WATER TREATMENT PLANT FOR  
INKANYEZI POULTRY FARM IN CALM, GERT SIBANDE DISTRICT

**BID NUMBER: AS PER BID BULLETIN**



NAME OF BIDDER : .....

BID AMOUNT : .....

COMPLETION PERIOD : .....

TEL NUMBER : .....

FAX NUMBER : .....

|  |  |
|--|--|
| <p><b>PREPARED FOR:</b></p>  <p>HEAD OF DEPARTMENT<br/>MPUMALANGA DEPT. OF AGRICULTURE, RURAL<br/>DEVELOPMENT, LAND AND ENVIRONMENTAL<br/>AFFAIRS<br/>PRIVATE BAG X11219<br/>NELSPRUIT<br/>1200</p> | <p><b>PREPARED BY:</b></p>  <p>5 Gips Avenue, Arcon Park, Vereeniging, 1939</p> <p><b>Contact Person:</b> Eng J Jiyane (Pr Eng)<br/>Email: <a href="mailto:injiyane@gmail.com">injiyane@gmail.com</a><br/>Cell: (071) 689 6890</p> |
|--|--|

**CLOSING DATE: AS PER BID BULLETIN  
THE BID IS VALID FOR 90 DAYS**



**RIVER ABSTRACTION PUMP STATION WITH WATER TREATMENT PLANT  
FOR INKANYEZI POULTRY FARM IN CALM, GERT SIBANDE DISTRICT.**

**DETAILS OF BIDDER**

**NAME OF BIDDER**

.....  
.....  
.....

**PHYSICAL ADDRESS**

.....  
.....  
.....

**POSTAL ADDRESS**

.....  
.....  
.....

**CONTACT PERSON**

(NAME)

.....

(SURNAME)

.....

(PHONE No)

.....

(CELL No)

.....

(FAX No)

.....

(E-MAIL)

.....

## **MPUMALANGA DEPARTMENT OF AGRICULTURE, RURAL DEVELOPMENT, LAND AND ENVIRONMENTAL AFFAIRS**

### **RIVER ABSTRACTION PUMP STATION WITH WATER TREATMENT PLANT FOR INKANYEZI POULTRY FARM IN CALM, GERT SIBANDE DISTRICT.**

#### **Contents:**

#### **Page:**

#### **Part T1: BID procedures**

|      |  |           |
|------|--|-----------|
| T1.1 | Notice and Invitation to BID           | T5 - T6   |
| T1.2 | BID Data                               | T7 - T15  |
| T1.3 | Annexure F: Standard Conditions of BID | T16 - T24 |

#### **Part T2: Returnable schedules**

|      |                              |           |
|------|------------------------------|-----------|
| T2.1 | List of Returnable Documents | T25 - T26 |
| T2.2 | Returnable Schedules         | T27 - T77 |

#### **Part C1: Agreement and Contract Data**

|      |                              |          |
|------|------------------------------|----------|
| C1.1 | Form of Offer and Acceptance | C1 - C6  |
| C1.2 | Contract Data                | C7 - C24 |

#### **Part C2: Pricing data**

|      |                      |           |
|------|----------------------|-----------|
| C2.1 | Pricing Instructions | C25 - C27 |
| C2.2 | Bill of Quantities   | C28 - C29 |

#### **Part C3: Scope of Work**

|      |                           |           |
|------|---------------------------|-----------|
| C3.1 | Description of Works      | C32       |
| C3.2 | Project Specifications    | C33 - C49 |
| C3.3 | Particular Specifications | C50 - C80 |

#### **Part C4: Site Information**

|      |                   |     |
|------|-------------------|-----|
| C4.1 | Locality Plan     | C82 |
| C4.2 | Site Notice Board | C83 |

**SCHEDULE OF BID DRAWINGS**

**Part C5: Drawings**

| Number           | Description                              |
|------------------|--|
| P2325-SEW-LP-300 | NKANYEZI SITE LAYOUT                     |
| P2325-SEW-LP-301 | NKANYEZI LONGITUDINAL SECTION            |
| P2325-SEW-LP-302 | WATER PUMPING METHOD                     |
| P2325-SEW-LP-303 | NKANYEZI WTW DIAGRAMATIC LAYOUT          |
| P2325-SEW-LP-304 | ELEVATED WATER TANK - 200m <sup>2</sup>  |
| P2325-SEW-LP-306 | SCOUR VALVE CHAMBER DETAILS              |
| P2325-SEW-LP-307 | AIR AND SCOUR VALVE CHAMBER DETAILS      |
| P2325-SEW-LP-308 | STANDARD VALVES AND FIRE HYDRANT DETAILS |
| P2325-SEW-LP-309 | PUMP STATION DETAILS - SHEET 1 OF 2      |
| P2325-SEW-LP-310 | PUMP STATION DETAILS - SHEET 2 OF 2      |
| P2325-SEW-LP-311 | WATER STANDARD DETAILS SHEET 2 OF 2      |
| P2325-SEW-LP-312 | WATER STANDARD DETAILS SHEET 2 OF 2      |

## PART T1: BID PROCEDURES

| <b>TABLE OF CONTENTS</b> |  | <b>Page</b> |
|--------------------------|--|-------------|
| <b>T1.1:</b>             | <b>NOTICE AND INVITATION TO BID.....</b>           | <b>T.5</b>  |
| <b>T1.2:</b>             | <b>BID DATA .....</b>                              | <b>T.8</b>  |
| <b>T1.3:</b>             | <b>ANNEXURE F: STANDARD CONDITIONS OF BID.....</b> | <b>T.17</b> |



**MPUMALANGA PROVINCIAL GOVERNMENT  
DEPARTMENT OF AGRICULTURE, RURAL DEVELOPMENT, LAND AND ENVIRONMENTAL  
AFFAIRS**

**RIVER ABSTRACTION PUMP STATION WITH WATER TREATMENT PLANT FOR INKANYEZI  
POULTRY FARM IN CALM, GERT SIBANDE DISTRICT**

**BID NUMBER: AS PER BID BULLETIN**

The Mpumalanga Department of Agriculture, Rural Development, Land and Environmental Affairs invites bids for the: RIVER ABSTRACTION PUMP STATION WITH WATER TREATMENT PLANT FOR INKANYEZI POULTRY FARM IN CALM, GERT SIBANDE DISTRICT. The works consist of the construction of the bulk water supply pump station at Nkomati River, bulk delivery pipeline and the treat plant for Nkanyezi farm. **Service Providers should have a CIDB contractor grading of 6CE or higher.**

BID documents will be obtainable from the following supply chain management offices **Mbombela Riverside Government Complex, Malelane 24 air Street Street, Siyabuswa Old Parliament Building, Middleburg Department of Public Works, KwaMhlanga Government Complex Department of Finance, Piet Retief no. 11 Mearsorch Street, No 5 Van Eck Street, Secunda (opposite Sasol Value Gas Garage), Elukwatini Sub-Regional Offices and The Provincial Treasury, R40 Road, Bakoena Business Complex, Bushbuckridge**, on payment of a non-refundable levy of R150.00 or can be downloaded at <http://www.etenders.gov.za/content/advertised-tenders>. Only card or cash payment will be accepted and document can be collected between 7:45 and 16:00.

**The closing date for receipt of bids is: As per bid bulletin 2026 at 12h00 PM.**

Duly completed bids enclosed in a sealed envelope marked "RIVER ABSTRACTION PUMP STATION WITH WATER TREATMENT PLANT FOR INKANYEZI POULTRY FARM IN CALM, GERT SIBANDE DISTRICT." with the name of the Bidder, shall be deposited in the clearly marked BID boxes provided at the following Supply Chain Offices: **Mbombela, Malelane, KwaMhlanga, Middleburg, Piet Retief, Bushbuckridge, Siyabuswa, Elukwatini and Secunda. The bids will be opened in public.**

A Compulsory Site Briefing will be conducted on **As per bid bulletin 2026** and prospective service providers are requested to meet the Employer / Representative at **As per bid bulletin** at Nkanyezi Poultry farm for site briefing. The project site is about 5km outside of Tjakastad Town, off R541 road from Emanzana to eMbanweni. Prospective bidders are expected to locate the place well in time to minimise getting lost during the day of briefing.

**Nkanyezi Poultry Farm coordinates are as follows: (-25.985923 S, 30.844564"E)**

Telegraphic, telephonic, telex, facsimile, e-mail and late bids **WILL NOT** be accepted.

Bidders should ensure that bids are delivered on time to the correct address. If the bid is late, it will not be accepted for consideration.

All documentation submitted in response to this bid must be in English, unless otherwise indicated under technical specification.

|  |   |
|--|---|
| <p><b>Employer:</b><br/>For:<br/><br/>AGRICULTURE, RURAL DEVELOPMENT, LAND AND ENVIRONMENTAL AFFAIRS<br/>PRIVATE BAG X11219<br/>NELSPRUIT<br/>1200<br/><br/>Contact Person: Ms TA Memela<br/>Email: <a href="mailto:thabie04@yahoo.co.za">thabie04@yahoo.co.za</a><br/>Tel: 063 698 3253</p> | <p><b>Engineer:</b></p>  <p>5 Gips Avenue, Arcon Park, Vereeniging, 1939<br/><br/><b>Contact Person:</b> Eng J Jiyane (Pr Eng)<br/>Email: <a href="mailto:jnjiyane@gmail.com">jnjiyane@gmail.com</a><br/>Cell: (071) 689 6890</p> |
|--|---|

## T1.2. BID DATA

The Conditions of BID in the Standard Conditions of BID as contained in Annex F of CIDB Standard Uniformity in Construction Procurement. (See [www.cidb.org.za](http://www.cidb.org.za)) which are reproduced without amendment or alteration for the convenience of the prospective service providers in this BID in the section T1.3 of the BID Data.

The Standard Conditions of BID make several references to the BID Data for details that apply specifically to this BID. The BID Data shall have precedence in the interpretation of any ambiguity or inconsistency between it and the Standard Conditions of BID. Each item of BID Data given below is cross-referenced to the relevant clause in the standard Conditions of BID.

**F.1.1** The Employer for this Contract is: **Mpumalanga Department of Agriculture, Rural Development, Land and Environmental Affairs**

### **F.1.2** **BID Documents**

**The BID Document consists of the following:**

#### **BID**

##### **T1: BID Procedures**

- T1.1: Notice and Invitation to BID
- T1.2: BID Data
- T1.3: Annexure F: Standard Conditions of BID

##### **T2: Returnable Documents**

- T2.1: List of Returnable Documents
- T2.2: Returnable schedules

#### **CONTRACT**

##### **Part 1: Agreements and Contract Data**

- C1.1: Form of Offer and Acceptance
- C1.2: Contract Data
- C1.3: Form of Guarantee
- C1.4: Agreement with Adjudicator
- C1.5: Agreement in terms of Section 37(2) of the Occupational Health and Safety Act (No 85, 1993)

##### **Part 2: Pricing Data**

- C2.1: Pricing Instructions
- C2.2: Bill of Quantities

##### **Part 3: Scope of Work**

- C3.1: Standard Specifications
- C3.2: Project Specifications
- C3.3: Particular Specifications

##### **Part 4: Site Information**

- C4.1: Locality Plan
- C4.2: Construction Notice Board

#### **DRAWINGS**

Drawings form part of this bid document.

**F.1.4 The Employer's agent is:**

AgriEng Consulting represented by Eng Jiyane J (Pr Eng)

**F.1.5 The Employer's right to accept or reject any bid Offer**

The Employer may accept or reject any variation, deviation, Bid Offer, or alternative Offer, and may cancel the bid process and reject all bid Offers at any time before the formation of a Contract. The Employer shall not accept or incur any liability to a service provider for such cancellation and rejection, but will give written reasons for such action upon written request to do so.

**F.2.1 Eligibility**

1. A service provider will not be eligible to submit a bid if:
  - (a) The service provider submitting the bid is under restrictions or has principals who are under restriction to participate in the Employer's procurement due to corrupt or fraudulent practices;
  - (b) The service provider does not have the legal capacity to enter into the Contract;
  - (c) The service provider submitting the bid is insolvent, in receivership, bankrupt or being wound up, has his affairs administered by a court or a judicial officer, has suspended his business activities, or is subject to legal proceedings in respect of the foregoing;
  - (d) The service provider does not comply with the legal requirements stated in the Employer's procurement policy;
  - (e) The service provider cannot demonstrate that s/he possesses the necessary professional and technical qualifications and competence, financial resources, equipment and other physical facilities, managerial capability, personnel, experience and reputation to perform the Contract;
  - (f) The service provider cannot provide proof that he is in good standing with respect to duties, taxes, levies and contributions required in terms of legislation applicable to the work in the Contract.
  - (g) Only those service providers who have in their employ management and supervisory staff satisfying the requirements of the Scope of Work for Labour Intensive Competencies for supervisory and management staff are eligible to submit BIDs.

**2. CIDB GRADING**

- I. Only those service providers who are registered with the CIDB as defined in the Regulations 09 June 2015 and 05 July 2019, in terms of the CIDB Act No 38 of 2000, or are capable of being so prior to the evaluation of submissions, in a Contractor grading designation equal to or higher than a Contractor grading designation determined in accordance with the Sum bid for a 6CE or higher class of Civil Engineering work, are eligible to submit bids.
- II. Joint Ventures are eligible to submit bids provided that:
  1. every member of the Joint Venture is registered with the CIDB;
  2. the lead partner has a Contractor grading designation in the 6CE or higher class of Civil Engineering work; and
  3. the combined Contractor grading designation calculated in accordance with the Construction Industry Development Regulations is equal to or higher than a Contractor grading designation determined in accordance with the Sum bid for a 6CE or higher class of Civil Engineering work.

---

## **F.2.7 Site visit and clarification meeting**

The arrangements for the compulsory site inspection visit and clarification meeting are as follows:

**Meeting place:** Project site at Nkanyezi Poultry farm for a briefing. The project site is outside of Tjakastad.

**Project Location:** Site Coordinates are as follows: (-25.985923 S, 30.844564"E)

Service providers are requested to meet the Employer / Engineer for a briefing session meeting for the bid: **River abstraction pump station with water treatment plant for Inkanyezi Poultry Farm in CALM, Gert Sibande District.**

As follow:

**Date:** As per bid bulletin 2026

**Starting time:** As per bid bulletin 2026

Enquiries of site location, and briefing session meeting must be made at least one full working day in advance and may be directed to:

Eng J Jiyane (Pr Eng)  
Cell:072 654 8272  
Email: [jnjiyane@gmail.com](mailto:jnjiyane@gmail.com)

Or

Ms TA Memela  
Cell: 063 698 3253

**Service Providers must sign the attendance register and name of their business entity. Addenda will be issued and BIDs will be received only from those business entities appearing on the attendance list.**

## **F.2.10 Pricing the bid Offer**

### **(a) Value Added Tax**

- The Valued Added Tax (VAT) rate shall be 15% or as otherwise provided for by Legislation.
- The successful service provider shall be required to produce a VAT invoice that shall only be prepared once measurements and valuations for work done in Terms of Contract Offer have been agreed with the Employers agent and a Certificate of Payment issued.
- Payment of VAT to non-VAT vendors shall be processed from the month in which the service provider's liability with the South African Revenue Services is effective.

## **F.2.11 Alterations to document**

A BID Offer shall not be considered if alterations have been made to the Forms of BID data or Contract data (unless such alterations have been duly authenticated by the service provider) or if any particulars required therein have not been completed in all respects.

## **F.2.12 Alternative bid Offers**

No alternative Offers will be considered.

## **F2.13 Submitting a bid Offer**

### **F.2.13.3 BID Offers shall be submitted as an original only.**

Under no circumstances whatsoever may the bid forms be retyped or redrafted.

Photocopies of the original BID documentation may be used, but an original signature must appear on such photocopies.

**F.2.13.5** The Employer's address for delivery of bid Offers and identification details to be shown on such bid Offer package are:

|                        |   |
|------------------------|---|
| Location of BID box:   | <b>As indicated in Bid Notice</b>   |
| Physical address:      | As indicated in BID Notice  |
| Identification details | BID for: River abstraction pump station with water treatment plant for Inkanyezi Poultry Farm in CALM, Gert Sibande District. |

Bid No: **As per bid bulletin 2026**  
Closing Date: **As per bid bulletin , at 12h00**

**F.2.15 Closing Time**

The closing time for submission of bid Offers is: **12h00 on As per bid bulletin** as stated in the Notice and Invitation to bid.

Telephonic, telegraphic, telex, facsimile, electronic or e-mailed BIDs will not be accepted.

**F.2.16 Bid Offer validity**

The bid Offer validity period is **90 days** from the closing time for submission of BIDs.

**F.2.18 Provide other material**

The service provider shall, when requested by the Employer to do so, submit the names of all management and supervisory staff that will be employed to supervise the labour-intensive portion of the works together with satisfactory evidence that such staff members satisfy the eligibility requirements

**F.2.19 Access**

Access shall be provided for inspections and testing by personnel acting on behalf of the Employer.

**F.2.22 Return of bid Documents**

Not applicable.

**F.2.21 EVALUATION PROCESS**

1.1. The valuation process comprises of the following phases:

**1.1.1 Phase I: Initial Screening Process**

During this phase, bid documents will be reviewed to determine compliance with the following:

- SBD forms (SBD 1, SBD 4, SBD 6.1 and SBD 6.2) must be fully completed and signed by the bidder.
- Bidders must attend the compulsory briefing session and must sign the attendance register.
- The Bill of Quantities (BoQ) must be fully completed and signed by the bidder. Where a BOQ item has been scratched or corrected the supplier is required to initial or counter sign next to the amendment.
- Signed Joint Venture Agreement and Power of Attorney in case of Joint Ventures;
- Bidders must indicate the total bid offer on the cover page as per the grand total on the Bill of quantity.
- Bidders must submit a company profile which includes a list of previous contract work done, value of the work and contactable references per contract.
- Bidders must submit a Certificate of Contractor Registration issued by the Construction Industry Development Board. Where a service provider satisfies a 6CE or higher CIDB Contractor grading designation requirements through Joint Venture formation, such service providers must submit the

Certificates of Contractor Registration in respect of each partner.

**All bidders must be registered on the Central Supplier Database (CSD) failure to do so will be automatically disqualified.**

**NB: It is the responsibility of the bidder to ensure that the following key information is in order to avoid any disqualification during the bid evaluations:**

- The Business registration status
- Bid restrictions and defaulters status
- Identification number and the service of the state status

**Failure to submit or adhere to the above “Phase I” requirements will lead to automatic disqualification.**

### 1.1.2 Phase II: Local Content Calculation

- **All bidders who passed the first phase will be evaluated on the correctness and completeness of the annexure C of the Local Production and content**

**The following items are part of the BoQ and are designated according to the Department of Trade and industry (DTI)**

| <b>Designated items</b>                        | <b>Designated percentage</b> |
|--|------------------------------|
| Cement   | 100                          |
| Polyvinyl chloride (PVC) pipes                 | 100                          |
| Plastic Pipes (PVC, HDPE, PE)                  | 100                          |
| Polypropylene (PP) pipes                       | 100                          |
| Valves and actuators                           | 70                           |
| Electrical cables                              | 90                           |
| Transformers and shunt reactors                | 90                           |
| Steel Products and Components for Construction | 100                          |

- A bidder who will score below the stipulated percentage must have an exemption letter from DTI that they are allowed to be further evaluated on functionality even if they have scored below the stipulated percentage.
- A bidder must calculate each item separately as per the Guidance Document for the Calculation for Local Content (attached)
- The instruction notes from National Treasury are attached as a guidance on all designated sectors
- The exchange rate to be used for the calculation of local production and content will be the exchange rate published by the South African Reserve Bank (SARB) at 12:00 on the date of advertisement of the bid; and only the South African Bureau of Standard (SABS) approved technical specification number SATS 1286; 2011 must be used to calculate local content.
- The local content (LC) expressed, as a percentage of the bid price must be calculated in accordance with the following formula, which must be disclosed in the bid documentation:

$$LC = \left(1 - \frac{X}{Y}\right) * 100$$

Where

- X is the imported content in Rand
- Y is the bid price in Rand excluding value added tax (VAT)

- Prices referred to in the determination of x will be converted to Rand (ZAR) by using the exchange rate published by the SARB at 12:00 on the date of advertisement of the bid.
- The SABS approved technical specification number SATS 1286:2011 and the Guidance of the calculation of local together with the Local Content Declaration Templates (Annexure C (Local Content Declaration: Summary Schedule), D (Imported Content Declaration: Supporting Schedule to Annexure C) and E (Local Content Declaration: Supporting Schedule to Annexure C) are accessible to all potential bidders on the dti's

official website [http://www.thedit.gov.za/industrial\\_development/ip.jsp](http://www.thedit.gov.za/industrial_development/ip.jsp) at no cost .

### 1.2. Phase III: Functionality evaluation as per attached Terms of Reference

- Bids will be evaluated strictly according to the bid evaluation criteria stipulated in the terms of reference
- Bidders must as part of their bid documents, submit supportive documentation for all technical requirements as indicated hereunder. The panel responsible for scoring for the respective bids will evaluate and score all bids based on their submissions and the information provided.
- Bidders will not rate themselves, but need to ensure that all information is supplied as required. The Bid Evaluation committee (BEC) will evaluate and score all responsive bids and will verify all documents submitted by the bidders.
- The BEC members will individually evaluate the responses received against the following criteria as set out below:

| CRITERIA  | EVIDENCE  | VALUE | WEIGHTING |
|---|---|-------|-----------|
| <p><b>Plant, Tools and Equipment available for this contract</b></p> <ul style="list-style-type: none"> <li>• TLB</li> <li>• Excavator</li> <li>• LDV</li> <li>• 5 ton or more truck</li> </ul> <p><i>Attach proof of ownership (certified registration certificate, valid license disc) if owned by the Bidder</i></p> <p><b>OR</b></p> <p><i>Signed hiring arrangement that refer to this contract if intended to be leased/hired. Attach proof of ownership (certified registration certificate, valid license disc) for hired equipment.</i></p> <p><i>Certification should not be more than 6 months by the closing of bid</i></p> | No information or inadequate information submitted to determine the scoring level | 1     | 15        |
|   | Bidder attached anyone (1) of the stipulated plant/equipment.                     | 2     |           |
|   | Bidder attached any two (2) of the stipulated plant/equipment.                    | 3     |           |
|   | Bidder attached any three (3) of the stipulated plant/equipment.                  | 4     |           |
|   | Bidder attached any four (4) of the stipulated plant/equipment.                   | 5     |           |
| <p><b>Details of staff available for this Contract:</b></p> <ul style="list-style-type: none"> <li>• BSc/BEng/BTech/Diploma in Civil/Agricultural Engineering.</li> <li>• Safety Officer: certificate in OHSA, First Aid, Emergency Medical</li> <li>• A qualified plumber registered with Plumbing Industry Registration Board (PIRB)</li> <li>• A professional construction project manager registered with SACPCMP.</li> </ul> <p><i>Attach CVs, certified copies of qualifications, proof of registration with relevant body and signed letters of</i></p>  | No information or inadequate information submitted to determine the scoring level | 1     | 25        |
|   | One (1) of the stipulated staff   | 2     |           |
|   | Two (2) of the stipulated staff   | 3     |           |
|   | Three (3) of the stipulated staff   | 4     |           |
|   | Four (4) of the stipulated staff  | 5     |           |

| CRITERIA  | EVIDENCE  | VALUE | WEIGHTING  |
|---|---|-------|------------|
| <i>consent from the relevant personnel, referring to this bid document. Certification should not be more than 6 months by the closing of bid. SAQA verification certificate will be required for qualifications obtained outside South Africa</i> |   |       |            |
| <b>Understanding of Scope of work</b>   | No information or inadequate information submitted to determine the scoring level   | 1     | 20         |
| <i>Attach Programme of Works in Gantt Chart format, clearly indicating milestones/activities, timelines, resources and cashflow projections</i>   | Bidder attached the Gantt chart with milestones/activities  | 2     |            |
|   | Bidder attached Gantt Chart only indicating milestones/activities and timelines   | 3     |            |
|   | Bidder attached Gantt Chart only indicating milestones/activities, timelines and resources  | 4     |            |
|   | Bidder attached Gantt Chart clearly indicating milestones/activities, timelines, resources and cashflow projections                                     | 5     |            |
| <b>Experience relevant to this technical field</b>  | No information or inadequate information submitted to determine the scoring level   | 1     | 25         |
| <b>Water related infrastructure projects</b>  | Bidder attached one (1) signed Completion Certificate   | 2     |            |
|   | Bidder attached two (2) signed Completion Certificates  | 3     |            |
|   | Bidder attached three (3) signed Completion Certificates  | 4     |            |
|   | Bidder attached Four (4) or more signed Completion Certificates   | 5     |            |
| <i>Attach Completion fully signed Certificates</i>  |   |       |            |
| <b>Commitment to appoint unskilled labour from the local community</b>  | No information or inadequate information submitted to determine the scoring level   | 1     | 15         |
| <i>Attach a signed letter with reference to this contract and an indication of the number of labourers to be appointed from the local community</i>   | Bidder attached a letter that is not signed   | 2     |            |
|   | Bidder attached signed letter with NO reference to this contract or NO indication of the number of labourers to be appointed from the local community   | 3     |            |
|   | Bidder attached signed letter with reference to this contract WITHOUT an indication of the number of labourers to be appointed from the local community | 4     |            |
|   | Bidder attached signed letter with reference to this contract and an indication of the number of labourers to be appointed from the local community     | 5     |            |
| <b>Total</b>  |   |       | <b>100</b> |

**Only bidders who attain a minimum of 70 percent on Functionality will qualify to proceed for further evaluation on Price and Preference points.**

e) Each panel member will rate each individual criterion on the score sheet using the following scale:

**1-Poor, 2- Average, 3- Good, 4- Very Good, 5- Excellent**

f) Individual value scores will be multiplied with the specified weighting for the criterion to obtain the marks scored for all elements. These marks will be added and expressed as a fraction of the best possible score for all criteria. This score will be converted to a percentage and only bidders that have met or exceeded the

minimum threshold of 70% for functionality will be evaluated and scored in terms of pricing and socio-economic goals as indicated hereunder.

- g) The value scored for each criterion will be multiplied with the specified with weighting for the relevant criterion to obtain the marks scored for each criterion. These marks will be added and expressed as a fraction of the best possible score for all criteria.
- h) This score will be converted to a percentage and only bidders that have met or exceeded the minimum threshold of 70 percent for functionality will be evaluated and scored in terms of pricing and socio economic goals as indicated hereunder.
- i) Any proposal not meeting a minimum score of 70 percent functionality proposal will be disqualified.
- j) The price will not be evaluated as this stage

**1.2.1 Phase III: Price / Financial stage**

- a) Price / Financial proposal must be submitted in South African Rand.
- b) The following formula will be used to calculate the points for price in respect of this bid:  

$$P_s = 80 \left( 1 - \frac{P_t - P_{min}}{P_{min}} \right)$$

Where

Ps= Points scored for comparative price of bid under consideration

Pt= Comparative price of bid under consideration

P min = Comparative price of lowest acceptable bid

- c) **The responsive bids will be adjudicated by the State on the 80/20-preference point system based on price points and preference point:**
  - The bid price (maximum 80 points)
  - Specific goals (maximum 20 points)
- d) The department reserves the right to arrange contracts with more than one contractor.
- e) The Preferential Procurement Policy Framework Act 2000 (PPPFA) Preferential Procurement Regulations 2022, Regulations were gazetted on 4 November 2022

(No. 47553) Vol 689 and effective from 16 January 2023. These bid will be evaluated as per above mentioned regulations. Bidders are required to submit evidence by which preference points can be claimed based on the specific goals determined by the Department.

In case a Joint Venture, the average score of the joint venture companies will be considered for determining preference point score. Subcontracting will be allowed for up to 25% of the value of the Contract to a company that possess the same or higher preference point score in terms of specific goals.

- f) A maximum of 20 points may be awarded to a bidder for full compliance with specific goals requirements stipulated in the table below. For this bid the maximum number of points status that could be allocated to a bidder is indicated below:

| Specific Goal                       | Maximum Preference Points Allocated | Minimum Proof required for claiming preference points  |
|-------------------------------------|-------------------------------------|--|
| An Enterprise owned by black people | 4                                   | CIPC enterprise registration certificate, certified ID copies of company owners and certified Accredited B-BBEE status level contributor certificate or signed |

|   |   |   |
|---|---|---|
|   |   | sworn affidavit   |
| An Enterprise owned by youth (35 years or younger)  | 2   | CIPC enterprise registration certificate, certified ID copies of company owners and certified Accredited B-BBEE status level contributor certificate or signed sworn affidavit  |
| An Enterprise owned by women  | 2   | CIPC enterprise registration certificate, certified ID copies of company owners and certified Accredited B-BBEE status level contributor certificate or signed sworn affidavit  |
| An Enterprise owned by people with a disability   | 4   | CIPC enterprise registration certificate, certified ID copies of company owners, Accredited B-BBEE status level contributor certificate or certified and signed sworn affidavit and Proof of disability (Certificate from a medical doctor that specifies the nature of the disability)   |
| An Enterprise owned by Military Veterans  | 4   | CIPC enterprise registration certificate, certified ID copies of company owners and certified Accredited B-BBEE status level contributor certificate or signed sworn affidavit<br>Confirmation letter from the Department of Military Veterans confirming the individual status as military veteran and that they have not been dishonably charged or honourably discharged from the military organisation or force |
| Promotion of South African Owned companies through the promotion of local manufacturers- local production and content<br><b>Local production and content designated items and designated percentage required to claim preference points:</b> <ul style="list-style-type: none"> <li>• Cement – 100%</li> <li>• Polyvinyl chloride (PVC) pipes – 100%</li> <li>• Plastic Pipes (PVC, HDPE, PE) – 100%</li> <li>• Polypropylene (PP) pipes – 100%</li> <li>• Valves and actuators – 70%</li> <li>• Electrical cables – 90%</li> <li>• Transformers and shunt reactors – 90%</li> <li>• Steel Products and Components for Construction – 100%</li> </ul> | 4<br><br>NB: (Points are allocated only when the bidder meets the designated percentage for all listed items) | A written declaration signed by the Enterprise with an indication of local production and content designated percentage for all goods listed on the specific goal and Annexure C (Local Content Declaration: Summery Schedule)  |
| <b>TOTAL</b>  | <b>20 POINTS</b>  |   |

**Failure to submit the required evidence will lead to allocation of zero (0) preference points**

- g) The points scored by a bidder in respect of the points indicated above will be added to the points scored for price.
- h) Bidders are requested to complete SBD 6.1 to claim preference points and attach relevant evidence as stipulated on the table above.
- i) Only a bidder who has completed and signed the declaration part of the preference claim form will be considered for preference points.

- j) Supply Chain Management may, before a bid is adjudicated or at any time, require a bidder to substantiate claims it has made with regard preference points.
- k) Points scored will be rounded off to the nearest 2 decimals.
- l) In the event that two or more bids have scored equal total points, the contract will be awarded to the bidder scoring the highest number of preference points. Should two or more bids be equal in all respects, the award shall be decided by drawing of lots.
- m) A contract may, on reasonable and justifiable grounds, be awarded to a bid that did not score the highest number of points. The bidder must submit copies of identity documents of all directors or shareholders of the company with the bid documents at the closing date and time of the bid.

### 1.3 Phase IV: Vetting

Shortlisted bidders will be required to undergo the vetting procedure to verify the authenticity of the submitted documents during the submission period and bidder can be eliminated if discovered that false information was submitted and this doesn't mean that the bid is automatically awarded to you.

### CLIENT BASE

Bidders are required to have specific experience and are encouraged to provide at least four recent references, in writing on the company's letterhead. The references may include the names of the relevant persons as well as their phone numbers, fax numbers, and e-mail addresses.

DARDLEA may utilize this data to obtain information during the evaluation and/or adjudication process.

### LEGAL IMPLICATIONS

Successful service providers must be prepared to enter into a service level agreement with the DARDLEA. DARDLEA reserves the right to award this bid on a non-exclusive basis, i.e. DARDLEA may procure similar services outside this bid with the view of securing the best service and value for money.

### COMMUNICATION

Supply Chain Management will communicate with bidders for, among others. Where bid clarity is sought, to obtain information or to extend the validity period. Any communication either by facsimile, letter or electronic mail or any other form of correspondence to any government official, department or representative of a testing institution or a person acting in an advisory capacity for DARDLEA in respect of this bid between the closing date and the award of the bid by the bidder is prohibited.

### COUNTER CONDITIONS

Bidders' attention is drawn to the fact that amendments to any of the Special Conditions by bidders will result in invalidation of such bids.

### PROHIBITION OF RESTRICTIVE PRACTICES

- a. In terms of section 4(1) of the Competition Act No. 89 of 1998, as amended, an agreement between, or concerted practice by, firms or a decision by an association of firms, is prohibited if it is between parties in a horizontal relationship and if a bidder(s) is/are or a contractor(s) was/were involved in:
  - Directly or indirectly fixing a purchase or selling price or any other trading condition;
  - Dividing markets by allocation customers, suppliers, territories or specific types of goods or services; or
  - Collusive bidding.
- b) If a bidder(s) or contractor(s), in the judgment of purchaser, has/have engaged in any of the restrictive practises referred to above, the purchaser may, without prejudice to any other remedy provided for, invalidate the bid(s) for such items(s) offered or terminate the contract in whole or in part and refer the matter to the Competition Commission for investigation and possible imposition of administrative penalties as contemplated in the Competition Act no.89 of 1998.

### FRONTING

DARDLEA supports the spirit of broad based black economic empowerment and recognizes that real empowerment can only be achieved through individuals and businesses conduction themselves in accordance with the Constitution and in an honest, fair, equitable, transparent and legally compliant manner. Against this background DARDLEA condemns any form of fronting.

---

DARDLEA, in ensuring that bidders conduct themselves in an honest manner will, as part of the bid evaluation processes, conduct or initiate the necessary enquiries/investigations to determine the accuracy of the representation made in bid documents. Should any of the fronting indicators as contained in the Guidelines on Complex Structures and Transactions and Fronting, issued by the Department of Trade and Industry be established during such enquiry/investigation, the onus will be on the bidder / contractor to prove that fronting does not exist.

Failure to do so within a period of 14 days from date of notification may invalidate the bid/contract and may also result in the restriction of the bidder/contractor to conduct business with public sector for a period not exceeding ten years, in addition on any other remedies DARDLEA may have against the bidder/contractor concerned.

## PRESENTATION

DARDLEA may require presentations/interviews from short-listed bidders as part of the bid process

### F.3.13 Acceptance of BID Offer

#### F.3.13.1 BID offers will only be accepted on condition that:

- (a) The BID Offer is signed by a person authorised to sign on behalf of the service provider;
- (b) the service provider's declaration of compliance with the Occupational Health and Safety Act No. 85 of 1993 and the Construction Regulations 2003, is included with her/his BID submission;
- (c) a service provider who submitted a BID as a Joint Venture has included an acceptable Joint Venture Agreement with her/his bid;
- (d) the service provider or a competent authorised representative of the Contractor who submitted the BID has attended the compulsory clarification meeting or site inspection;
- (e) the Contractor who submits the bid has been registered with the Construction Industry Development Board in accordance with the Construction Industry Development Board Act No. 38 of 2000 and the CIDB Regulations 2003 promulgated in terms of the Act, or if the Contractor can submit proof or evidence that s/he will be able to register within 10 days of the closing date for submission of BIDs;
- (f) the service provider or any of its principals is not listed on the register of BID Defaulters in terms of the Prevention and Combating of Corrupt Activities Act of 2004 as a person prohibited from doing business with the Public Sector;
- (g) the service provider has not abused the Employer's Supply Chain Management System or has failed to perform on any previous Contract and has been given a written notice to this effect;
- (h) The service provider or any of its Principals, Directors or Managers is not employed in the service of the State (all spheres of government) nor is a Public Representative (Councillor);
- (i) a company profile is attached;
- (j) the required Certificates listed in F.2.23 above, are attached;
- (k) The Returnable Schedules in T2.2 have been completed and signed;
- (l) The Form of Offer in C1.1 has been signed by the Service Provider;
- (m) the Employer is satisfied that the service provider or any of her/his Principals have not influenced the BID Offer and acceptance by the following criteria:
  - a. having Offered, promised or given a bribe or other gift or remuneration to any person in connection with the obtaining or execution of this Contract;
  - b. having acted in a fraudulent or corrupt manner in obtaining or executing this Contract;

- c. having approached an Officer or employee of the Employer or the Employer's Agent with the objective of influencing the award of a Contract in the service provider's favour;
- d. having entered into any agreement or arrangement, whether legally binding or not, with any other Person, Firm or Company to refrain from Quoting for this Contract or as to the amount of the BID to be submitted by either party;
- e. having disclosed to any other Person, Firm or Company other than the Employer, the exact or approximate amount of his proposed BID;
- f. The Employer may, in addition to using any other legal remedies, repudiate the BID Offer and acceptance and declare the Contract invalid should it have been concluded already.

**F.3.18 Copies of Contract**

The number of paper copies of the signed Contract to be provided by the Employer is ONE.

### **T1.3: Annex F: Standard Conditions of Bid**

**(As contained in Annexure F of South African National Standard: Construction procurement processes, Methods and procedures: SANS 294: 2004 Edition)**

#### **F.1 General**

##### **F.1.1 Actions**

The employer and each service provider submitting a Bid offer shall comply with these conditions of Bid. In their dealings with each other, they shall discharge their duties and obligations as set out in F.2 and F.3, timeously and with integrity, and behave equitably, honestly and transparently.

##### **F.1.2 Bid Documents**

The documents issued by the employer for the purpose of a Bid offer are listed in the Bid data.

##### **F.1.3 Interpretation**

**F.1.3.1** The Bid data and additional requirements contained in the Bid schedules that are included in the returnable documents are deemed to be part of these conditions of Bid.

**F.1.3.2** These conditions of Bid, the Bid data and Bid schedules which are only required for Bid evaluation purposes, shall not form part of any contract arising from the invitation to Bid.

**F.1.3.3** For the purposes of these conditions for the calling for expressions of interest, the following definitions apply:

- a) **comparative offer** means the service providers financial offer after the factors of non-firm prices, all unconditional discounts and any other Bided parameters that will affect the value of the financial offer have been taken into consideration
- b) **corrupt practice** means the offering, giving, receiving or soliciting of anything of value to influence the action of the employer or his staff or agents in the Bid process; and
- c) **Fraudulent practice** means the misrepresentation of the facts in order to influence the Bid process or the award of a contract arising from a Bid offer to the detriment of the employer, including collusive practices intended to establish prices at artificial levels
- d) **Quality (functionality)** means the totality of features and characteristics of a product or service that bear on its ability to satisfy stated or implied needs

##### **F.1.4 Communication and employer's agent**

Each communication between the employer and a service provider shall be to or from the employer's agent only, and in a form that can be read, copied and recorded. Writing shall be in the English language. The employer shall not take any responsibility for non-receipt of communications from or by a service provider. The name and contact details of the employer's agent are stated in the Bid data.

##### **F.1.5 The employer's right to accept or reject any Bid offer**

**F.1.5.1** The employer may accept or reject any variation, deviation, Bid offer, or alternative Bid offer, and may cancel the Bid process and reject all Bid offers at any time before the formation of a contract. The employer may accept any Bid offer in part or in full and split the Bid to award to one or more Bid offers. The employer shall not accept or incur any liability to a service provider for such cancellation and rejection, but will give written reasons for such action.

**F.1.5.2** After the cancellation of a Bid process or the rejection of all Bid offers the employer may abandon the proposed procurement and re-issue a similar Bid notice and invitation to Bid not less than three months after the closing dated for Bid offers or have it performed in another manner at any time.

### **F.1.5.3 Price negotiations**

- The department may negotiate the price offered by the bidder who scored the highest points if the prices are considered to be above the market analysis.
- If the price offered by the bidder scoring the highest points is not market-related, the department may negotiate a market-related price with the bidder scoring the highest points, and if in agreement, a service level agreement will be entered into by both parties.
- If the bidder scoring the highest points does not agree to a market-related price and can prove beyond reasonable doubt that the price offered by the department is not according to the market the department may consider reviewing the prices based on the quotes provided by the supplier.
- If the bidder scoring the highest points does not agree to a market-related price the department shall negotiate a market-related price with the second bidder, if the bidder scoring the second highest points does not agree to a market-related price the department shall negotiate a market-related price with the bidder scoring the third highest points.
- If the market-related price is not agreed to as envisaged by the first, second, and third bidder the department shall cancel the bid.

## **F.2 Service Providers obligations**

The service provider shall comply with the following obligations:

### **F.2.1 Eligibility**

Submit a Bid offer only if the service provider complies with the criteria stated in the Bid data and the service provider, or any of his principals, is not under any restriction to do business with employer.

### **F.2.2 Cost of Biding**

Accept that the employer will not compensate the service provider for any costs incurred in the preparation and submission of a Bid offer, including the costs of any testing necessary to demonstrate that aspects of the offer satisfy requirements.

### **F.2.3 Check documents**

Check the Bid documents on receipt for completeness and notify the employer of any discrepancy or omission.

Bidders shall check the numbers of the pages and satisfy themselves that none are missing or duplicated. No liability shall be accepted in regard to claims arising from the fact that pages are missing or duplicated.

### **F.2.4 Confidentiality and copyright of documents**

Treat as confidential all matters arising in connection with the Bid. Use and copy the documents issued by the employer only for the purpose of preparing and submitting a Bid offer in response to the invitation.

### **F.2.5 Reference documents**

Obtain, as necessary for submitting a Bid offer, copies of the latest versions of standards, specifications, conditions of contract and other publications, which are not attached but which are incorporated into the Bid documents by reference.

### **F.2.6 Acknowledge addenda**

Acknowledge receipt of addenda to the Bid documents, which the employer may issue, and if necessary apply for an extension to the closing time stated in the Bid data, in order to take the addenda into account.

### **F.2.7 Clarification meeting**

Attend, where required, a clarification meeting at which service providers may familiarize themselves with aspects of the proposed work, services or supply and raise questions. Details of the meeting(s) are stated in the Bid data.

## **F.2.8 Seek clarification**

Request clarification of the Bid documents, if necessary, by notifying the employer at least five working days before the closing time stated in the Bid data.

## **F.2.9 Insurance**

Be aware that the extent of insurance to be provided by the employer (if any) may not be for the full cover required in terms of the conditions of contract identified in the contract data. The service provider is advised to seek qualified advice regarding insurance.

## **F.2.10 Pricing the Bid offer**

**F.2.10.1** Include in the rates, prices, and the Bided total of the prices (if any) all duties, taxes (except Value Added Tax (VAT)), and other levies payable by the successful service provider, such duties, taxes and levies being those applicable 14 days before the closing time stated in the Bid data.

**F.2.10.2** Show VAT payable by the employer separately as an addition to the Bided total of the prices.

**F.2.10.3** Provide rates and prices that are fixed for the duration of the contract and not subject to adjustment except as provided for in the conditions of contract identified in the contract data.

**F.2.10.4** State the rates and prices in Rand unless instructed otherwise in the Bid data. The conditions of contract identified in the contract data may provide for part payment in other currencies.

## **F.2.11 Alterations to documents**

Not make any alterations or additions to the Bid documents, except to comply with instructions issued by the employer, or necessary to correct errors made by the service provider. All signatories to the Bid offer shall initial all such alterations. Erasures and the use of masking fluid are prohibited.

## **F.2.12 Alternative Bid offers**

**F.2.12.1** Submit alternative Bid offers only if a main Bid offer, strictly in accordance with all the requirements of the Bid documents, is also submitted. The alternative Bid offer is to be submitted with the main Bid offer together with a schedule that compares the requirements of the Bid documents with the alternative requirements the service provider proposes.

**F.2.12.2** Accept that an alternative Bid offer may be based only on the criteria stated in the Bid data or criteria otherwise acceptable to the employer.

## **F.2.13 Submitting a Bid offer**

**F.2.13.1** Submit a Bid offer to provide the whole of the works, services or supply identified in the contract data and described in the scope of works, unless stated otherwise in the Bid data.

**F.2.13.2** Return all returnable documents to the employer after completing them in their entirety, either electronically (if they were issued in electronic format) or by writing in black ink.

**F.2.13.3** Submit the parts of the Bid offer communicated on paper as an original plus the number of copies stated in the Bid data, with an English translation of any documentation in a language other than English, and the parts communicated electronically in the same format as they were issued by the employer.

**F.2.13.4** Sign the original and all copies of the Bid offer where required in terms of the Bid data. The employer will hold all authorized signatories liable on behalf of the service provider. Signatories for service providers proposing to contract as joint ventures shall state which of

the signatories is the lead partner whom the employer shall hold liable for the purpose of the Bid offer.

**F.2.13.5** Seal the original and each copy of the Bid offer as separate packages marking the packages as "ORIGINAL" and "COPY". Each package shall state on the outside the employer's address and identification details stated in the Bid data, as well as the service providers name and contact address.

**F.2.13.6** Where a two-envelope system is required in terms of the Bid data, place and seal the returnable documents listed in the Bid data in an envelope marked "financial proposal" and place the remaining returnable documents in an envelope marked "technical proposal". Each envelope shall state on the outside the employer's address and identification details stated in the Bid data, as well as the service provider's name and contact address.

**F.2.13.7** Seal the original Bid offer and copy packages together in an outer package that states on the outside only the employer's address and identification details as stated in the Bid data.

**F.2.13.8** Accept that the employer shall not assume any responsibility for the misplacement or premature opening of the Bid offer if the outer package is not sealed and marked as stated.

#### **F.2.14 Information and data to be completed in all respects**

Accept that Bid offers, which do not provide all the data or information requested completely and in the form required, may be regarded by the employer as non-responsive.

#### **F.2.15 Closing time**

**F.2.15.1** Ensure that the employer receives the Bid offer at the address specified in the Bid data not later than the closing time stated in the Bid data. Proof of posting shall not be accepted as proof of delivery. The employer shall not accept Bid offers submitted by telegraph, telex, facsimile or e-mail, unless stated otherwise in the Bid data.

**F.2.15.2** Accept that, if the employer extends the closing time stated in the Bid data for any reason, the requirements of these conditions of Bid apply equally to the extended deadline.

#### **F.2.16 Bid offer validity**

**F.2.16.1** Hold the Bid offer(s) valid for acceptance by the employer at any time during the validity period stated in the Bid data after the closing time stated in the Bid data.

**F.2.16.2** If requested by the employer, consider extending the validity period stated in the Bid data for an agreed additional period.

#### **F.2.17 Clarification of Bid offer after submission**

Provide clarification of a Bid offer in response to a request to do so from the employer during the evaluation of Bid offers. This may include providing a breakdown of rates or prices and correction of arithmetical errors by the adjustment of certain rates or item prices (or both). No change in the total of the prices or substance of the Bid offer is sought, offered, or permitted. The total of the prices stated by the service provider shall be binding upon the service provider.

**Note:** Sub-clause F.2.17 does not preclude the negotiation of the final terms of the contract with a preferred service provider following a competitive selection process, should the Employer elect to do so.

#### **F.2.18 Provide other material**

**F.2.18.1** Provide, on request by the employer, any other material that has a bearing on the Bid offer, the service providers commercial position (including notarized joint venture

agreements), preferencing arrangements, or samples of materials, considered necessary by the employer for the purpose of a full and fair risk assessment. Should the service provider not provide the material, or a satisfactory reason as to why it cannot be provided, by the time for submission stated in the employer's request, the employer may regard the Bid offer as non-responsive.

**F.2.18.2** Dispose of samples of materials provided for evaluation by the employer, where required.

### **F.2.19 Inspections, tests and analysis**

Provide access during working hours to premises for inspections, tests and analysis as provided for in the Bid data.

### **F.2.20 Submit securities, bonds, policies, etc.**

If requested, submit for the employer's acceptance before formation of the contract, all securities, bonds, guarantees, policies and certificates of insurance required in terms of the conditions of contract identified in the contract data.

### **F.2.21 Check final draft**

Check the final draft of the contract provided by the employer within the time available for the employer to issue the contract.

### **F.2.22 Return of other Bid documents**

If so instructed by the employer, return all retained Bid documents within 28 days after the expiry of the validity period stated in the Bid data.

### **F.2.23 Certificates**

Include in the Bid submission or provide the employer with any certificates as stated in the Bid data.

## **F.3 The employer's undertakings**

### **The employer undertakes to:**

#### **F.3.1 Respond to clarification**

Respond to a request for clarification received up to five working days prior to the Bid closing time stated in the Bid Data and notify all service providers who drew procurement documents.

#### **F.3.2 Issue Addenda**

If necessary, issue addenda that may amend or amplify the Bid documents to each service provider during the period from the date of the Bid Notice until seven days before the Bid closing time stated in the Bid Data. If, as a result a service provider applies for an extension to the closing time stated in the Bid Data, the Employer may grant such extension and, will then notify it to all service providers who drew documents.

#### **F.3.3 Return late Bid offers**

Return Bid offers received after the closing time stated in the Bid Data, unopened, (unless it is necessary to open a Bid submission to obtain a forwarding address), to the service provider concerned.

#### **F.3.4 Opening of Bid submissions**

**F.3.4.1** Unless the two-envelope system is to be followed, open valid Bid submissions in the presence of service providers' agents who choose to attend at the time and place stated in

the Bid data. Bid submissions for which acceptable reasons for withdrawal have been submitted will not be opened.

**F.3.4.2** Announce at the opening held immediately after the opening of Bid submissions, at a venue indicated in the Bid data, the name of each service provider whose Bid offer is opened, the total of his prices, preferences claimed and time for completion, if any, for the main Bid offer only.

**F.3.4.3** Make available the record outlined in F.3.4.2 to all interested persons upon request.

### **F.3.5 Two-envelope system**

**F.3.5.1** Where stated in the Bid data that a two-envelope system is to be followed, open only the technical proposal of valid Bids in the presence of service providers' agents who choose to attend at the time and place stated in the Bid data and announce the name of each service provider whose technical proposal is opened.

**F.3.5.2** Evaluate the quality of the technical proposals offered by service providers, then advise service providers who remain in contention for the award of the contract of the time and place when the financial proposals will be opened. Open only the financial proposals of service providers, who score in the quality evaluation above the minimum number of points for quality stated in the Bid data, and announce the score obtained for the technical proposals and the total price and any preferences claimed. Return unopened financial proposals to service providers whose technical proposals failed to achieve the minimum number of points for quality.

### **F.3.6 Non-disclosure**

Not disclose to service providers, or to any other person not officially concerned with such processes, information relating to the evaluation and comparison of Bid offers, the final evaluation price and recommendations for the award of a contract, until after the award of the contract to the successful service provider.

### **F.3.7 Grounds for rejection and disqualification**

Determine whether there has been any effort by a service provider to influence the processing of Bid offers and instantly disqualify a service provider (and his Bid offer) if it is established that he engaged in corrupt or fraudulent practices.

### **F.3.8 Test for responsiveness**

Determine, on opening and before detailed evaluation, whether each Bid offer properly received:

- a) meets the requirements of these Conditions of Bid,
- b) has been properly and fully completed and signed, and
- c) is responsive to the other requirements of the Bid documents.

A responsive Bid is one that conforms to all the terms, conditions, and specifications of the Bid documents without material deviation or qualification. A material deviation or qualification is one which, in the Employer's opinion, would:

- detrimentally affect the scope, quality, or performance of the works, services or supply identified in the Scope of Work,
- change the Employer's or the service provider's risks and responsibilities under the contract,
- or affect the competitive position of other service providers presenting responsive Bids, if it were to be rectified.

Reject a non-responsive Bid offer, and not allow it to be subsequently made responsive by correction or withdrawal of the non-conforming deviation or reservation.

**F.3.9 Arithmetical errors**

Check responsive Bid offers for arithmetical errors, correcting them in the following manner:

- Where there is a discrepancy between the amounts in figures and in words, the amount in words shall govern.
- If a bill of quantities (or schedule of rates) apply and there is an error in the line item total resulting from the product of the unit rate and the quantity, the line item total shall govern and the rate shall be corrected. Where there is an obviously gross misplacement of the decimal point in the unit rate, the line item total as Bided shall govern, and the unit rate will be corrected.
- Where there is an error in the total of the prices either as a result of other corrections required by this checking process or in the service providers’ addition of prices, the total of the prices shall govern and the service provider will be asked to revise selected item prices (and their rates if a bills of quantities applies) to achieve the Bided total of the prices.

Consider the rejection of a Bid offer if the service providers does not correct or accept the correction of his arithmetical errors in the manner described above.

**F.3.10 Clarification of a Bid offer**

Obtain clarification from a service provider on any matter that could give rise to ambiguity in a contract arising from the Bid offer.

**F.3.11 Evaluation of Bid offers**

**F.3.11.1 General**

Appoint an evaluation panel of not less than three persons. Reduce each responsive Bid offer to a comparative offer and evaluate it using the Bid evaluation method that is indicated in the Bid Data and described below:

|   |  |
|---|--|
| Method 1:<br>Financial offer                          | 1) Rank Bid offers from the most favorable to the least favorable comparative offer.<br>2) Recommend highest ranked service provider for the award of the contract, unless there are compelling and justifiable reasons not to do so.  |
| Method 2:<br>Financial offer and preferences          | 1) Score Bid evaluation points for financial offer.<br>2) Confirm that service providers are eligible for the preferences claimed and if so, score Bid evaluation points for preferencing.<br>3) Calculate total Bid evaluation points.<br>4) Rank Bid offers from the highest number of Bid evaluation points to the lowest.<br>5) Recommend service provider with the highest number of Bid evaluation points for the award of the contract, unless there are compelling and justifiable reasons not to do so. |
| Method 3:<br>Financial offer and quality              | 1) Score quality, rejecting all Bid offers that fail to score the minimum number of points for quality stated in the Bid data.<br>2) Score Bid evaluation points for financial offer.<br>3) Calculate total Bid evaluation points.<br>4) Rank Bid offers from the highest number of Bid evaluation points to the lowest.<br>5) Recommend service provider with the highest number of Bid evaluation points for the award of the contract, unless there are compelling and justifiable reasons not to do so.      |
| Method 4:<br>Financial offer, quality and preferences | 1) Score quality, rejecting all Bid offers that fail to score the minimum number of points for quality stated in the Bid data.<br>2) Score Bid evaluation points for financial offer.<br>3) Confirm that service providers are eligible for the preferences claimed, and if so, score Bid evaluation points for preferencing.<br>4) Calculate total Bid evaluation points.<br>5) Rank Bid offers from the highest number of Bid evaluation points to the lowest.   |

6) Recommend service provider with the highest number of Bid evaluation points for the award of the contract, unless there are compelling and justifiable reasons not to do so.

Score financial offers, preferences and quality, as relevant, to two decimal places.

### F.3.11.2 Scoring Financial Offers

Score the financial offers of remaining responsive Bid offers using the following formula:

- $N_{FO}$  =  $W_1 \times A$ ; where:  
 $N_{FO}$  = the number of Bid evaluation points awarded for the financial offer.  
 $W_1$  = the maximum possible number of Bid evaluation points awarded for the financial offer as stated in the Bid Data.  
 $A$  = a number calculated using either formulas 1 or 2 below as stated in the Bid Data.

| Formula | Basis for comparison                      | Option 1                      | Option 2 |
|---------|---|-------------------------------|----------|
| 1       | Highest price or discount                 | $(1 + \frac{(P - P_m)}{P_m})$ | $P/P_m$  |
| 2       | Lowest price or percentage commission/fee | $(1 - \frac{(P - P_m)}{P_m})$ | $P_m/P$  |

where:

- $P_m$  = the comparative offer of the most favourable Bid.  
 $P$  = the comparative offer of Bid under consideration.

### F.3.11.3 Scoring quality (functionality)

Score quality in each of the categories stated in the Bid Data and calculate total score for quality.

### F.3.12 Insurance provided by the employer

If requested by the proposed successful service provider, submit for the service providers information the policies and / or certificates of insurance which the conditions of contract identified in the contract data, require the employer to provide.

### F.3.13 Acceptance of Bid offer

**F.3.13.1** Accept Bid offer only if the service provider satisfies the legal requirements stated in Clause F.2.1 of the Bid Data.

**F.3.13.2** Notify the successful service provider of the employer's acceptance of his Bid offer by completing and returning one copy of the form of offer and acceptance before the expiry of the validity period stated in the Bid data, or agreed additional period. Providing the form of offer and acceptance does not contain any qualifying statements, it will constitute the formation of a contract between the employer and the successful service provider as described in the form of offer and acceptance.

### F.3.14 Notice to unsuccessful Service providers

After the successful service provider has acknowledged the employer's notice of acceptance, notify other service providers that their Bid offers have not been accepted.

### F.3.15. Prepare contract documents

If necessary, revise documents that shall form part of the contract and that were issued by the employer as part of the Bid documents to take account of:

- a) Addenda issued during the Bid period,
- b) Inclusion of some of the returnable documents,

- c) Other revisions agreed between the employer and the successful service provider, and
- d) The schedule of deviations attached to the form of offer and acceptance, if any.

#### **F.3.16 Issue final contract**

Prepare and issue the final draft of contract documents to the successful service provider for acceptance as soon as possible after the date of the employer's signing of the form of offer and acceptance (including the schedule of deviations, if any). Only those documents that the conditions of Bid require the service provider to submit, after acceptance by the employer, shall be included.

#### **F.3.17 Complete adjudicator's contract**

Unless alternative arrangements have been agreed or otherwise provided for in the contract, arrange for both parties to complete formalities for appointing the selected adjudicator at the same time as the Main contract is signed.

#### **F.3.18 Provide copies of the contracts**

Provide to the successful service provider the number of copies stated in the Bid Data of the signed copy of the contract as soon as possible after completion and signing of the form of offer and acceptance.

## **PART T2: RETURNABLE SCHEDULES**

| <b>TABLE OF CONTENTS</b> |   | <b>Page</b> |
|--------------------------|---|-------------|
| <b>T2.1:</b>             | <b>LIST OF RETURNABLE DOCUMENTS.....</b>                                  | <b>T.26</b> |
| <b>T2.2:</b>             | <b>RETURNABLE SCHEDULES TO BE COMPLETED<br/>BY SERVICE PROVIDERS.....</b> | <b>T.28</b> |

## **PART T2: RETURNABLE SCHEDULES**

### **T2.1 List of Returnable Documents**

The Service Providers must complete the following Returnable Documents in the Appendix

The complete bid document as received from the employer, together with all additional documentation as requested, must be submitted. No documentation must be removed from the bid document.

#### **Compulsory Returnable Documents:**

- Legal Joint Venture Agreement (where applicable);
- Valid letter of Good Standing from the Department of Labour;
- CIDB registration Certificate;
- Proof of Registration with the Central Supplier Database;

NB: It is the responsibility of the bidder to ensure that the following key information is in order to avoid any disqualification during the bid evaluations:

- .....The Business registration status
- .....Tender restrictions and defaulters status
- .....Identification number and the service of the state status

**Non-submission of any of the above listed documents may lead to disqualification of the bid.**

- **Returnable Schedules**

The bidder must complete the following returnable documents:

#### **Returnable Schedules required only for bid evaluation purposes**

- Record of Addenda to Bid Documents;
- Proposed Amendments, Deviations and Alternatives;
- Bidder's previous experience;
- List of traceable references for similar services;
- Schedule of plant and equipment;
- Schedule of proposed subcontractors (if applicable)
- Preliminary Execution Programme;
- Capacity: Signed CVs of staff with letter of consent, certified proof of Qualification(s) not older than six (6) months and organogram;
- Company profile;

**Other schedules and documents that will be incorporated into the contract and must be completed & submitted to be considered responsive**

- Fully completed and signed Compulsory Enterprise Questionnaire;
- Fully completed and signed Certificate of Authority for Signatory;
- Schedule of amendments, deviations and alternatives;
- Contractor's health and safety declaration;
- Fully completed and signed all SBD forms
- The Bill of Quantities (BoQ) must be fully completed and signed
- Attendance of site briefing meeting and signing of attendance register
- Notification Form in Terms of the Occupational Health and Safety Act 1993, Construction Regulations 2003
- Offer and Acceptance
- Contract Data
- Pricing schedule
- Other

River abstraction pump station with water treatment plant for Inkanyezi Poultry Farm in CALM, Gert Sibande District.

---

.....  
.....  
.....

**Note that the bid document must be fully completed and signed, failure which may result in disqualification of the bid.**

**5 The Offer portion**

- Part C1 Agreement and Contract Data
- Part C2 Pricing Data
- Part C3 Scope of Work
- Part C4 Site Information

**Note that the bid document must be fully completed and signed, failure which may result in disqualification of the bid.**

## **T2.2 Returnable Schedules to be completed by Service Provider**

## **THE CONTRACT**

**PART C1: AGREEMENTS AND CONTRACT DATA**

**PART C2: PRICING DATA**

**PART C3: SCOPE OF WORK**

**PART C4: SITE INFORMATION**

**MPUMALANGA DEPARTMENT OF AGRICULTURE, RURAL DEVELOPMENT, LAND AND ENVIRONMENTAL AFFAIRS**

**RIVER ABSTRACTION PUMP STATION WITH WATER TREATMENT PLANT FOR INKANYEZI POULTRY FARM IN CALM, GERT SIBANDE DISTRICT**

**TABLE OF CONTENTS**

**PART C1: AGREEMENTS AND CONTRACT DATA**

**C1.1: FORM OF OFFER AND ACCEPTANCE**

**C1.2: CONTRACT DATA**

**C1.2.1: CONDITIONS OF CONTRACT**

**C1.2.2: PART A: CONTRACT DATA PROVIDED BY THE EMPLOYER**

**PART B: CONTRACT DATA PROVIDED BY THE CONTRACTOR**

**C1.3: FORM OF GUARANTEE**

**C1.4: AGREEMENT IN TERMS OF SECTION 37(2) OF THE OCCUPATIONAL HEALTH AND SAFETY ACT No 85 OF 1993**

**PART C2: PRICING DATA**

**C2.1: PRICING INSTRUCTIONS**

**C2.2: BILL OF QUANTITIES**

**PART C3: SCOPE OF WORK**

**TABLE OF CONTENTS**

**C3.1: STANDARD SPECIFICATIONS**

**C3.2: PROJECT SPECIFICATIONS**

**C3.3: PARTICULAR SPECIFICATIONS**

**PART C 4: SITE INFORMATION**

**C4.1: LOCALITY PLAN**

**C4.2: CONSTRUCTION NOTICE BOARD**

## **PART C1: AGREEMENTS AND CONTRACT DATA**

### **C1.1: FORM OF OFFER AND ACCEPTANCE**

### **C1.2: CONTRACT DATA**

#### **C1.2.1: CONDITIONS OF CONTRACT**

#### **C1.2.2: PART A: CONTRACT DATA PROVIDED BY THE EMPLOYER**

#### **PART B: CONTRACT DATA PROVIDED BY THE CONTRACTOR**

### **C1.3: FORM OF GUARANTEE**

### **C1.4: AGREEMENT IN TERMS OF SECTION 37(2) OF THE OCCUPATIONAL HEALTH AND SAFETY ACT (No 85 OF 1993)**

**MPUMALANGA DEPARTMENT OF AGRICULTURE, RURAL DEVELOPMENT LAND AND ENVIRONMENTAL AFFAIRS**

**RIVER ABSTRACTION PUMP STATION WITH WATER TREATMENT PLANT FOR INKANYEZI POULTRY FARM IN CALM, GERT SIBANDE DISTRICT**

**C1.1 Form of Offer and Acceptance**

**Offer**

The Employer, identified in the Acceptance Signature block, has solicited Offers to enter into a Contract for the procurement of:

**Contract No. As per bid bulletin**

The Service Provider, identified in the Offer Signature block, has examined the Documents listed in the Bid Data and addenda thereto as listed in the Returnable Schedules, and by submitting this Offer has accepted the Conditions of Bid.

By the representative of the Service Provider, deemed to be duly authorized, signing this part of this Form of Offer and Acceptance, the Service Provider Offers to perform all of the obligations and liabilities of the Contractor under the Contract including compliance with all its Terms and Conditions according to their true intent and meaning for an amount to be determined in accordance with the Conditions of Contract identified in the Contract Data.

**THE OFFERED TOTAL OF THE PRICES INCLUSIVE OF VALUE ADDED TAX IS:**

.....  
..... Rand (in words);  
**R** ..... (in figures)

This Offer may be accepted by the Employer by signing the Acceptance part of this Form of Offer and Acceptance and returning one copy of this Document to the Service Provider before the end of the period of validity stated in the Bid Data, whereupon the Service Provider becomes the Party named as the Contractor in the Conditions of Contract identified in the Contract Data.

| Signature Block: Service Provider |            |
|-----------------------------------|------------|
| Signature .....                   | Date ..... |
| Name .....                        |            |
| Capacity .....                    |            |
| Name of organization .....        |            |
| Address of organization .....     |            |
| .....                             |            |
| Signature of witness .....        | Date ..... |
| Name of witness .....             |            |

## Acceptance

By signing this part of this Form of Offer and Acceptance, the Employer identified below accepts the Service Providers Offer. In consideration thereof, the Employer shall pay the Contractor the amount due in accordance with the conditions of Contract identified in the Contract Data. Acceptance of the Service Providers Offer shall Form an Agreement between the Employer and the Service Providers upon the Terms and Conditions contained in this Agreement and in the Contract that is the subject of this Agreement.

The terms of the Contract, are contained in:

- Part C1: Agreements and Contract Data, (which includes this Agreement)
- Part C2: Pricing Data
- Part C3: Scope of work.
- Part C4: Site Information and Drawings and Documents or parts thereof, which may be incorporated by reference into Parts C1 to C4 above.

Deviations from and amendments to the Documents listed in the Bid Data and any addenda thereto as listed in the Bid Schedules as well as any changes to the Terms of the Offer agreed by the Service Provider and the Employer during this process of Offer and Acceptance, are contained in the Schedule of Deviations attached to and Forming part of this Agreement. No amendments to or deviations from said Documents are valid unless contained in this schedule.

The Service Provider shall within two weeks after receiving a completed copy of this Agreement, including the Schedule of Deviations (if any), contact the Employer's agent (whose details are given in the Contract Data) for delivery of any Bonds, Guarantees, proof of Insurance and any other Documentation to be provided in terms of the Conditions of Contract Identified in the Contract Data. Failure to fulfil any of these Obligations in accordance with those terms shall constitute a repudiation of this Agreement.

Notwithstanding anything contained herein, this Agreement comes into effect on the date when the Service Provider receives one fully completed original copy of this Document, including the Schedule of Deviations (if any). Unless the Service Provider (now Contractor) within five working days of the date of such receipt notifies the Employer in writing of any reason why he cannot accept the Contents of this Agreement, this Agreement shall constitute a binding Contract between the Parties.

| Signature Block: Employer  |                           |
|----------------------------|---------------------------|
| Signature .....            | Date .....                |
| Name .....                 |                           |
| Capacity .....             |                           |
| <b>for the Employer</b>    | <b>Mpumalanga DARDLEA</b> |
| Signature of witness ..... | Date .....                |
| Name of witness .....      |                           |

## Schedule of Deviations

1 Subject .....  
Details .....  
.....  
.....  
.....

2 Subject .....  
Details .....  
.....  
.....  
.....

3 Subject .....  
Details .....  
.....  
.....  
.....

4 Subject .....  
Details .....  
.....  
.....  
.....

5 Subject .....  
Details .....  
.....  
.....  
.....

By the duly Authorised Representatives signing this Agreement, the Employer and the Service Provider agree to and accept the foregoing Schedule of Deviations as the only deviations from and amendments to the Documents listed in the Bid Data and addenda thereto as listed in the Bid Schedules, as well as any confirmation, clarification or changes to the terms of the Offer agreed by the Service Provider and the Employer during this process of Offer and Acceptance.

It is expressly agreed that no other matter whether in writing, oral communication or implied during the period between the issue of the Bid Documents and the receipt by the Service Provider of a completed signed copy of this Agreement shall have any meaning or effect in the Contract between the parties arising from this Agreement.

### Confirmation of receipt

The tenderer (now the Contractor), identified in the Offer part of this Agreement hereby confirms receipt from the Employer, identified in the Acceptance part of this Agreement, of one fully completed original copy of this Agreement, including the Schedule of Deviations (if any) today:

The .....(day) of.....(month) 20.....(year)

At.....(place)

For the Contractor:

.....  
Signature

.....  
Name

.....  
Capacity

Signature and name of witness:

.....  
Signature

.....  
Name

**MPUMALANGA DEPARTMENT OF AGRICULTURE, RURAL DEVELOPMENT, LAND AND ENVIRONMENTAL AFFAIRS**

**RIVER ABSTRACTION PUMP STATION WITH WATER TREATMENT PLANT FOR INKANYEZI POULTRY FARM IN CALM, GERT SIBANDE DISTRICT**

**C1.2 CONTRACT DATA**

**CONTENTS**

|               |                |  |
|---------------|----------------|--|
| <b>C1.2.1</b> | <b>Part 1:</b> | <b>Data provided by the Employer</b>                     |
| C.1.2.1.1     |                | Conditions of Contract                                   |
| C.1.2.1.2     |                | Contract-specific Data                                   |
| C.1.2.1.2.1   |                | Compulsory Data  |
| C.1.2.1.2.2   |                | Variations to the General Conditions of Contract         |
| C.1.2.1.2.3   |                | Additional Clauses to the General Conditions of Contract |

## **C1.2.1 Part 1: Data provided by the Employer**

### **C.1.2.1.1 Conditions of Contract**

The conditions of Contract are:

- the “General Conditions of Contract” as they appear in the commercially available publication “General Conditions of Contract for Construction Works, Third Edition, 2015”, hereinafter referred to as “GCC 2015”; and
- Specific data as contained in this Contract Data.

Each party to the Contract shall purchase its own copy of the GCC 2015 that applies to this Contract, available from its publisher:

South African Institution of Civil Engineering  
Private Bag X200  
Halfway House  
1685  
South Africa

Tel +27 (0)11 805 5947

#### **The following notes apply:**

##### **Note 1**

The GCC 2015 makes several references to the Contract Data.

Each item of data below is cross-referenced to the clause in the Conditions of Contract to which it applies. Notwithstanding anything specified to the contrary, the Contract Data shall take precedence in the interpretation of any ambiguity or inconsistency between it and the GCC 2015.

The documents forming the Contract are to be taken as mutually explanatory of one another. For the purpose of interpretation, the priority of the documents shall be in accordance with the following order of precedence:

- (a) the Form of Offer and Acceptance.
- (b) amendments to the General Conditions of Contract within the Contract Data.
- (c) additional conditions to the General Conditions of Contract within the Contract Data.
- (d) corrigenda to the General Conditions of Contract.
- (e) the General Conditions of Contract.
- (f) the Specifications, Drawings, Schedules and other documents forming part of the Contract (in that order) contained in the Scope of Work and the Site Information.

If any ambiguity or discrepancy is found in the documents, the Engineer needs to be contacted to issue any necessary clarification or instruction.

##### **Note 2**

Certain pro-forma forms and pro-forma agreements contained in the GCC 2015 have been adapted for this particular contract. Those pro-forma forms and pro-forma agreements contained in the GCC 2015 do not apply where replaced by similar pro-forma forms and proforma agreements in this document.

### C.1.2.1.2 Contract-specific Data

The following contract-specific data, referring to the General Conditions of Contract, are applicable to this Contract:

#### C.1.2.1.2.1 Compulsory Data

| Clause   | Data  |
|----------|---|
| 1.1.1.13 | The Defects Liability is <b>12 months</b>   |
| 1.1.1.14 | The time for achieving Practical Completion is <b>eight (8) months</b>  |
| 1.1.1.15 | The name of the Employer is <b>Mpumalanga Department of Agriculture, Rural Development, Land and Environmental Affairs (DARDLEA)</b>  |
| 1.1.1.26 | The Pricing Strategy of a Re-measurement Contract shall apply   |
| 1.2.1.2  | <p>The address of the Employer is:</p> <p>Physical address:<br/>                     Government Complex Riverside<br/>                     1<sup>st</sup> Floor Bldg 6<br/>                     Nelspruit<br/>                     1200</p> <p>Postal address:<br/>                     Private Bag X11219<br/>                     Nelspruit<br/>                     1200</p> <p>e-mail address:<br/> <a href="mailto:thabie04@yahoo.co.za">thabie04@yahoo.co.za</a></p> <p>Contact numbers:<br/>                     Cel: 063 698 3253</p> |
| 1.1.1.16 | <p>The name of the Engineer is:<br/>                     Mr J Jiyane (Pr Eng)</p>   |
| 1.2.1.2  | <p>The address of the Engineer is:</p> <p>Physical address:<br/>                     5 Gips Avenue<br/>                     Arcon park<br/>                     Vereeniging<br/>                     1939</p> <p>Postal address:<br/>                     Private Bag X11219<br/>                     Nelspruit<br/>                     1200</p> <p>Mr J Jiyane (Pr Eng)<br/>                     Cell: 072 654 8272<br/>                     Email: <a href="mailto:injiyane@gmail.com">injiyane@gmail.com</a></p>                          |
| 4.9.1    | The Contractor shall deliver to the Engineer, on a monthly basis, a detailed inventory of Construction Equipment kept on Site, full particulars given for each day of the month. Distinction shall be made  |

|           |  |
|-----------|--|
|           | between Owned Equipment and Hired Equipment as well as Equipment in working order and Equipment out of order. Such inventory shall be submitted by the seventh day of the month following the month to be reported.  |
| 4.10.2    | The Contractor shall deliver to the Engineer, on a monthly basis, a return in detail of supervisory staff and the number of categorized classes of labour employed each day for the said period by the Contractor for execution of the Contract. Such return shall be submitted by the seventh day of the month following the month to be reported.  |
| 5.3.1     | The documentation required before commencement with Works execution are:<br><br>Health and Safety Plan (Refer to Clause 4.3)<br>A signed Agreement between the Employer and the Contractor for the Works to be completed by the Contractor in terms of the provisions of Section 37(2) of the Occupational Health and Safety Act (Act No.85 of 1993) and the Construction Regulations promulgated thereunder (Refer to Clause 4.3).<br>Proof of payment to the Employer, that the Contractor has paid all contributions required in terms of the Compensation for Occupational Injuries and Diseases Act, No 130 of 1993 (Refer to Clause 4.3).<br>Initial programme (Refer to Clause 5.6).<br>Security (Refer to Clause 6.2).<br>Insurance (Refer to Clause 8.6). |
| 5.3.2     | The time to submit the documentation required before commencement with Works execution is <b>14 Days</b> .   |
| 5.4.2     | The access and possession of Site shall not be exclusive to the Contractor but shall be as set out elsewhere in the Contract.  |
| 5.8.1     | The non-working Days are Sundays.<br><br>The special non-working Days are:<br><br>Statutory public holidays; and<br>All annual year-end shutdown periods as recommended by the South African Federation of Civil Engineering Contractors (SAFCEC), and which commence after the Commencement Date and which commence before the Due Completion Date.   |
| 5.13.1    | <b>The penalty for failing to complete the Works is 0,1 percent of contract price per calendar day.</b>  |
| 5.16.3    | The latent defect period is 10 years, commencing on the Day after the date of certification of Practical Completion.   |
| 6.10.1.5  | The percentage advance on materials not yet built into the Permanent Works is 80%. Proof of ownership is required.   |
| 6.10.3    | The limit of <b>retention money is 10%</b> of the value of the Contract Price.<br><b>A Retention Money Guarantee is compulsory.</b><br>A penalty will be applied for non-delivery of the Retention Money Guarantee as required. The penalty will be 10% of the value of the completion Retention Money Amount per calendar month for late delivery of the said Retention Money Guarantee.  |
| 8.6.1.1.2 | The value of Plant and materials supplied by the Employer to be included in the insurance sum is <b>nil</b> .  |
| 8.6.1.1.3 | The amount to cover professional fees for repairing damage and loss to be included in the insurance sum is a maximum of <b>10% (ten percent)</b> of the Contract Sum.  |
| 8.6.1.3   | The limit of indemnity for liability insurance is equal to the contract amount.  |
| 10.5.1    | Dispute resolution shall be by standing adjudication, use GCC 2015, Appendix 5.  |
| 10.7.1    | The determination of disputes shall be by arbitration.   |
|           | <b>Payment for labour-intensive component of the works</b><br><i>Payment for works identified in the Scope of Works as being labour-intensive shall only be made in accordance with the provisions of the Contract if the works are constructed strictly in accordance with the provisions of the Scope of Work. Any payment for such works shall not relieve the Contractor in any way from his obligations either in contract or in delict.</i>  |
|           | <b>Linkage of payment for labour-intensive component of works to submission of project data</b>  |

|  |  |
|--|--|
|  | <i>The Contractor's payment invoices shall be accompanied by labour information for the corresponding period in a format specified by the employer. If the contractor chooses to delay submitting payment invoices, labour returns shall still be submitted as per frequency and timeframe stipulated by the Employer. The contractor's invoices shall not be paid until all pending labour information has been submitted.</i>            |
|  | <b>Applicable Labour Laws</b><br><i>The current Ministerial Determination (also downloadable at <a href="http://www.epwp.gov.za">www.epwp.gov.za</a>), Expanded Public Works Programmes, issued in terms of the Basic Condition of Employment Act of 1997 by the Minister of Labour in Government Notice, shall apply to works described in the scope of work as being labour-intensive and which are undertaken by unskilled workers.</i> |

#### C.1.2.1.2.2 Variations to the General Conditions of Contract

| Clause   | Data  |
|----------|---|
| 2.5.1    | <b>Cession</b><br><br><i>Amend Clause 2.5.1 as follows:</i><br><br><i>Delete the words "without the written consent of the other"</i>   |
| 5.14.5.1 | <b>Consequences of Completion</b><br><br><i>Amend Clause 5.14.5.1 as follows:</i><br><br><i>In the second line, substitute the word 'Guarantor' with 'Contractor'.</i>  |
| 6.2      | <b>Security</b><br><br><i>Replace Sub-Clauses 6.2.1 and 6.2.2 with:</i><br><br>"The Contractor shall deliver to the Employer within such time as may be stated in the Contract Data, a Demand Guarantee, of an Insurance Company registered in terms of the Short-term Insurance Act (Act 53 of 1998) or of a registered Commercial Bank, in a sum equal to the amount stated in the Contract Data. The Demand Guarantee shall be issued by an entity subject to the approved of the Employer, and shall conform in all respects to the format contained in the Contract Data.<br><br>The security to be provided by the Contractor shall be a Demand Guarantee of 10% of the Contract Sum.<br><br>Wherever a joint venture constitutes the contracting party, the Demand Guarantee shall be issued on behalf of the joint venture.<br><br>Failure to produce an acceptable Demand Guarantee within the period stated in the Contract Data, is a fundamental breach of Contract, entitling the Employer to cancel the Contract by due notice in terms of Clause 9.2 with specific reference to Sub-clause 9.2.2 as amended in the Contract Data." |
| 6.3.1    | <b>Variations</b><br><br><i>Amend Clause 6.3.1, as follows:</i><br><br><i>In the first paragraph, third line, after the words "or for any reason appropriate", add the phrase ", including the limiting of contract expenditure so as not to exceed the Employer's budgeted project</i>   |

|               |   |
|---------------|---|
|               | <p>funding, "</p> <p><i>Add the following phrase to the last paragraph of Clause 6.3.1.6, after the words "ascertaining the amount of the Contract Price":</i></p> <p><i>", and no such variation shall give reason for consideration of any claim in terms of Clause 6.11."</i></p>                        |
| 6.3.2         | <p><b>Orders for Variations to be in writing</b></p> <p>Omit the words "Provided that" under Clause 6.3.2 and omit Clause 6.3.2.1.</p>  |
| 6.9.2         | <p><b>Definition of "materials"</b></p> <p><i>Amend Clause 6.9.2, as follows:</i></p> <p><i>Substitute the word 'plant' with 'Plant'.</i></p>   |
| 6.10.1        | <p><b>Interim Payments</b></p> <p><i>Amend Clause 6.10.1.5 as follows:</i></p> <p><i>In the third line, add the words 'not yet' before the words 'built into'</i></p>   |
| <b>Clause</b> | <b>Data</b>   |
| 6.10.5        | <p><b>Payment of retention money</b></p> <p><i>Amend Clause 6.10.5 as follows:</i></p> <p><i>In the second line, add the words ', if any,' after the words 'Defects Liability Period'</i></p>   |
| 6.10.6        | <p><b>Set-off and delayed payments</b></p> <p><i>Amend Clause 6.10.6.2 as follows:</i></p> <p><i>Delete the words 'simple interest' and substitute with the words 'interest compounded monthly'.</i></p> <p><i>Delete the words 'Contractor's Bank' and substitute with the words 'Employer's Bank'</i></p> |
| 6.11          | <p><b>Variations exceeding 15 per cent</b></p> <p><i>Replace the marginal heading with:</i></p> <p><b>"Variations exceeding 20 per cent"</b></p> <p><i>Replace "15 per cent" with "20 per cent" in the text of this Sub-Clause</i></p>  |
| 7.4.4         | <p><b>Cost of test specimens and tests</b></p> <p><i>Amend Clause 7.4.4.2 as follows:</i></p> <p><i>In the second line of paragraph two, add the words 'the requirements of' before the words 'the Contract'</i></p>  |
| 7.8.2         | <p><b>Cost of making good of defects</b></p> <p><i>Amend Clause 7.8.2.1 as follows:</i></p> <p><i>In the first line, correct the spelling of 'therefore'.</i></p>   |
| 8.1.3         | <p><b>Excessive loads and traffic</b></p>   |

|       |   |
|-------|---|
|       | In the third line, add a comma after the word 'Site' as follows: 'in the vicinity of the Site, from'.   |
| 8.3.1 | <p><b>Excepted risks</b></p> <p><i>Amend Clause 8.3.1.10 as follows:</i></p> <p><i>In the second line, delete the words 'Employer or any of their' and substitute with 'or any of its'.</i></p>   |
| 8.6.6 | <p><b>Contractor to produce proof of payment</b></p> <p>"The Contractor shall before commencement of the Works produce to the Engineer:</p> <p>8.6.6.1 The policies by which the insurances are effected,</p> <p>8.6.6.2 Proof that due payment of all premiums there under, covering the full required period has been made, and</p> <p>8.6.6.3 Proof of continuity of the policies for the required period.</p> <p>Should, during the currency of the Contract, the required period of insurance be extended for any reason, the Contractor shall timeously extend (so as to maintain) the said insurances for the full extended duration.</p> <p>The Engineer shall be empowered to withhold all payment certificates until the Contractor has complied with his obligations in terms of this Clause 8.6.6."</p>   |
| 8.6.7 | <p><b>Remedy on Contractor's failure to insure</b></p> <p><i>Delete sub-clause 8.6.7 and substitute with:</i></p> <p>"Failure on the part of the Contractor to effect and keep in force any of the insurances referred to in Clause 8.6.1 and its sub-clauses, is a fundamental breach of Contract, entitling the Employer to cancel the Contract by due notice in terms of Clause 9.2 and with specific reference to sub-clause 9.2.2, as amended in the Contract Data."</p>   |
| 9.1.2 | <p><b>State of emergency</b></p> <p><i>In the fourth line, delete the words 'supply of' and substitute with 'availability of'.</i></p>  |
| 9.2   | <p><b>Termination by Employer</b></p> <p><i>Delete the contents of Clause 9.2 and substitute with:</i></p> <p>"9.2.1 The Employer may terminate the Contract by written notice to the Contractor if:</p> <p>9.2.1.1 Sequestration of the Contractor's estate is ordered by a Court with due jurisdiction, or</p> <p>9.2.1.2 The Contractor publishes a notice of surrender or presents a petition for the surrender of his estate as insolvent, or makes a compromise with his creditors, or assigns in favour of his creditors, or agrees to carry out the Contract under the supervision of a committee representing his creditors, or (being a company) goes into liquidation, whether provisionally or finally (other than a voluntary liquidation for the purpose of amalgamation or reconstruction), or if the Contractor assigns the Contract without having first obtained the Employer's consent in writing, or if execution is levied on his goods, or</p> <p>9.2.1.3 The Contractor, or anyone on his behalf, or in his employ, offers to any person in the employ</p> |

|  |  |
|--|--|
|  | <p>of the Employer or the Engineer, a gratuity or reward or commission, or</p> <p>9.2.1.4 The Contractor furnished materially inaccurate information in his Tender, which had a bearing on the award of the Contract, or</p> <p>9.2.1.5 The Contractor has abandoned the Contract.</p>   |
|  | <p>9.2.2 If the Contractor:</p> <p>9.2.2.1 Has failed to commence the Works in terms of Clause 10 hereof, or has suspended the progress of the Works for fourteen (14) days after receiving from the Engineer written notice to proceed, or</p> <p>9.2.2.2 Has failed to provide the Guarantee in terms of Clause 7 within the time stipulated in the Contract Data, or</p> <p>9.2.2.3 Has failed to proceed with the Works with due diligence, or</p> <p>9.2.2.4 Has failed to remove materials from the Site or to pull down and replace work within fourteen (14) days after receiving from the Engineer written notice that the said materials or work have been condemned and rejected by the Engineer in terms of these conditions, or</p> <p>9.2.2.5 Is not executing the Works in accordance with the Contract, or is neglecting to carry out his obligations under the Contract, or</p> <p>9.2.2.6 Has, to the detriment of good workmanship or in defiance of the Engineer's instructions to the contrary, sublet any part of the Contract, or</p> <p>9.2.2.7 Has assigned the Contract or any part thereof without the Employer's consent in writing, then the Employer may give the Contractor 14 days' notice to rectify the default, and if the Contractor fails to rectify the default in said 14 days, then, without further notice, notify the Contractor in writing of the termination of the Contract and expel the Contractor and order the Contractor to vacate the site within 24 hours of issue of the Notice of Termination and to hand the Site over to the Employer, and the Employer may then enter upon the Site and the Works without affecting the rights and powers conferred on the Employer or the Engineer by the Contract and the Employer may himself complete the Works or may employ another contractor to complete the Works, and the Employer or such other contractor may use for such completion so much of the Construction Equipment, Temporary Works and materials brought onto the Site by the Contractor as the Employer may think proper, and the Employer may at any time sell any of the said Construction Equipment, Temporary Works and unused materials and apply the proceeds of sale towards payment of any sums that may be due or become due to the Employer by the Contractor under the Contract. In such circumstances the Contractor shall forthwith vacate the Site and shall not be entitled to remain on the Site on the grounds that he is entitled to do so on a right of retention until amounts due to him have been paid, neither will the Contractor be entitled to any further payments in terms of this Contract.</p> |
|  | <p>9.2.3 If the Contractor, having been given notice to rectify a default in terms of 9.2.2 above, rectifies said default, but later repeats the same or substantially the same default, then the Employer may notify the Contractor of the immediate termination of the Contract, and proceed as stated in the paragraph following the word 'writing' in Clause 9.2.2.7 above.</p>  |
|  | <p>9.2.4 Should the amounts that the Employer must pay to complete the Works, exceed the sum that would have been payable to the Contractor on due completion by him, then the Contractor shall upon demand pay to the Employer the difference, and it shall be deemed a debt due by the</p>   |

|  |   |
|--|---|
|  | <p>Contractor to the Employer and shall be recoverable accordingly. Provided that should the Contractor on demand not pay the amount of such excess to the Employer, such sum may be determined and deducted by the Employer from any sum due to or that may become due to the Contractor under this or any previous or subsequent contract between the Contractor and the Employer.”</p> |
|--|---|

**C.1.2.1.2.3 Additional clauses to the General Conditions of Contract:**

| Clause   | Data  |
|----------|---|
| 1.1      | <b>Definitions</b>  |
| 1.1.1.35 | <i>Add the following at the end of Sub-Clause 1.1.1:</i>  |
| 1.1.1.36 | <p>1.1.1.35 “Client”, as used in the Occupational Health and Safety Act – Construction Regulations, means Employer.</p> <p>1.1.1.36 “Principal Contractor”, as used in the Occupational Health and Safety Act - Construction Regulations, means Contractor.</p>   |
| 4.12     | <p><b>Contractor’s superintendence</b></p> <p><i>Add the following sub-clause 4.12.4 to Clause 4.12:</i></p> <p>“Where a form is included in the Contract Data for this purpose, the Tenderer shall fill in the name of the person he proposes to entrust with the post of Contractor’s Site Agent on this Contract in the space provided therefore. Previous experience of this person on work of a similar nature during the past five (5) years is to be entered on the form.</p> <p>The Contractor’s Site Agent shall be on Site at all times when work is being performed.</p> <p>The person shall be subject to approval of the Engineer in writing and shall not be replaced or removed from Site without the written approval of the Engineer.”</p> |
| 5.6      | <p><b>Programme</b></p> <p><i>Add the following sub-clause 5.6.6 to Clause 5.6:</i></p> <p>“Failure on the part of the Contractor to deliver to the Engineer, the</p> <ul style="list-style-type: none"> <li>• programme of the Works in terms of Clause 5.6.1 and</li> <li>• supporting documents in terms of Clause 5.6.2</li> </ul> <p>Within the period stated in the Contract Data, shall be sufficient cause for the Engineer to retain 25 per centum of the value of the Fixed Charge and Value-related items in assessment of amounts due to the Contractor, until the Contractor has submitted aforementioned first Programme of the Works and Supporting Documents”.</p>  |
| 5.9.7    | <p><b>Engineer to approve Contractor’s Designs and Drawings</b></p> <p><i>Add the following sub-clause 5.6.6 to Clause 5.6:</i></p> <p>“All designs, calculations, drawings and operation and maintenance manuals shall be fully endorsed by a third party registered engineer, accomplished in such specific field of practice and the cost thereof shall be borne solely by the Contractor.</p>   |

|                      |  |
|----------------------|--|
|                      | <p>Once the alternative design has been approved, the Contractor shall indemnify and hold harmless the Engineer, the Employer, their agents and assigns, against all claims howsoever arising out of the said design, whether in contract or delict”.</p>  |
| <p><b>Clause</b></p> | <p><b>Data</b></p>   |
| <p>5.11</p>          | <p><b>Suspension of the Works</b></p> <p><i>Add the following sub-clause 5.11.4 to Clause 5.11:</i></p> <p>“If the Contractor does not receive from the Employer the amount due under an Interim Payment Certificate within 28 days after expiry of the time stated in sub-clause 6.10.4 within which payment is to be made (except for deductions in accordance with sub-clauses 6.10.1.6 and 6.10.1.7), the Contractor may, after giving 14 days’ notice to the Employer, suspend the progress of the Works.</p> <p>The Contractor’s action shall not prejudice his entitlements to a claim in terms of Clause 10.1 and to cancellation of the Contract in terms of Clause 9.3.</p> <p>If the Contractor subsequently receives full payment of the amount due under such Interim Payment Certificate before giving a notice of cancellation of the Contract, the Contractor shall resume normal working as soon as is reasonably practicable.”</p> |
| <p>5.12</p>          | <p><b>Extension of Time for Practical Completion</b></p> <p><i>Add the following at the end of Sub-Clause 5.12.2.2:</i></p> <p>“The extension of time to be allowed due to abnormal rainfall shall be calculated separately for each calendar month or part thereof in accordance with the following formula:</p> $V = (Nw - Nn) + \frac{Rw - Rn}{x}$ <p>Where</p> <p>V = Extension of time in calendar days for the calendar month under consideration<br/> Nw = Actual number of days during the calendar month on which a rainfall of 10 mm or more has been recorded<br/> Nn = Average number of days for the calendar month on which a rainfall of 10 mm or more has been recorded, as derived from existing rainfall records<br/> Rw = Actual recorded rainfall for the calendar month<br/> Rn = Average rainfall for the calendar month, as derived from existing rainfall records<br/> x = 20</p>  |
|                      | <p>The rainfall records which shall provisionally be accepted for calculation purposes are:</p> <p>Based on records taken at:<br/> <b>RAINFALL STATION:</b><br/> <b>PERIOD:</b></p>  |

| Month     | Average rainfall for calendar month<br>Rn<br>(mm) | Average number of days for calendar month on which a rainfall of 10 mm or more were recorded<br>Nn<br>(days) |
|-----------|---|--|
| January   | 136   |  |
| February  | 115   |  |
| March     | 96  |  |
| April     | 47  |  |
| May       | 19  |  |
| June      | 8   |  |
| July      | 9   |  |
| August    | 15  |  |
| September | 28  |  |
| October   | 65  |  |
| November  | 110   |  |
| December  | 137   |  |

|      |   |
|------|---|
| 6.10 | <p><b>Payments</b></p> <p><i>Add the following at the end of Sub-Clause 6.10.1:</i></p> <p>“The Contractor shall complete the ‘Contractor’s Monthly Report Schedule’, which pro forma documentation is obtainable from the Engineer. Pursuant to Sub-Clause (1), these, duly signed by all concerned, together with the Contractor’s statement and a VAT invoice in original format are to be submitted to the Engineer. Issue by the Engineer to the Employer and Contractor of any signed payment certificate is conditional to this information being fully endorsed, accurately and timeously submitted to the Engineer”.</p> <p><i>Add the following at the end of Sub-Clause 6.10.1.5:</i></p> <p>“All documentary evidence of such materials shall be unambiguous with respect to ownership having fully passed to the Contractor on or before the date of submittal of the Contractor’s monthly statement. Should the Contractor fail to supply unambiguous documentary evidence, he shall, prior to submittal of his monthly statement, deliver to the Employer a Guarantor Guarantee in the form contained in the Appendices to the Contract Data.”</p> |
| 9.3  | <p><b>Termination by the Contractor</b></p> <p><i>Add the following at the end of Sub-Clause 9.3:</i></p> <p>9.3.5 “In addition to, or as an alternative to the rights to termination contained in this Clause 9.3, the Contractor may notify the default to the Employer, with a copy to the Engineer, and if the default is not rectified within 10 days the Contractor may suspend progress of the works until a date 7 days after the default is rectified. The Contractor shall be entitled to extension of time to the extent of delay caused by or resulting from such suspension, and to payment of additional costs caused by or resulting from the suspension. Such extension of time and additional costs shall be promptly ascertained by the Engineer, who shall then grant the extension of time and include the additional costs in all future payment certificates. Such suspension, extension of time and/or payment of additional costs, shall not prejudice the Contractor’s rights to cancel the contract.”</p>   |

**MPUMALANGA DEPARTMENT OF AGRICULTURE, RURAL DEVELOPMENT LAND AND ENVIRONMENTAL AFFAIRS**

**RIVER ABSTRACTION PUMP STATION WITH WATER TREATMENT PLANT FOR INKANYEZI POULTRY FARM IN CALM, GERT SIBANDE DISTRICT**

**C1.3 FORM OF GUARANTEE**

Contract No.

WHEREAS The **MPUMALANGA DEPARTMENT OF AGRICULTURE, RURAL DEVELOPMENT, LAND AND ENVIRONMENTAL AFFAIRS** (hereinafter referred to as the Employer”) entered into, a Contract with:

.....  
(Hereinafter called “the Contactor”) on the ..... day of ..... 26. ....  
For the NKANYEZI BULK WATER SUPPLY

AND WHEREAS it is provided by such Contract that the Contractor shall provide the Employer with security by way of a Guarantee for the due and faithful fulfilment of such Contract by the Contractor;

AND WHEREAS ..... has / have at the request of the Contractor, agreed to give such Guarantee;

NOW THEREFORE WE ..... do hereby Guarantee and bind ourselves jointly and severally as Guarantor and Co-principal Debtors to the Employer under renunciation of the benefits of division and execution for the due and faithful performance by the Contractor of all the Terms and Conditions of the said Contract, subject to the following Conditions:

1. The Employer shall, without reference and / or notice to us, have complete liberty of action to act in any manner authorized and/or contemplated by the terms of the said Contract, and/or to agree to any modifications, variations, alterations, directions or extensions of the completion date of the works under the said Contract, and that its rights under this Guarantee shall in no way be prejudiced nor our liability hereunder be affected by reason of any steps which the Employer may take under such Contract, or of any modification, variation, alterations of the completion date which the Employer may make, give, concede or agree to under the said Contract.
2. This Guarantee shall be limited to the payment of a sum of money.
3. The Employer shall be entitled, without reference to us, to release any Guarantee held by it, and to give time to or compound or make any other arrangement with the Contractor.
4. This Guarantee shall remain in full force and effect until the issue of the Certificate of Completion in terms of the Contract, unless we are advised in writing by the Employer before the issue of the said Certificate of his intention to institute claims, and the particulars thereof, in which event this Guarantee shall remain in full force and effect until all such claims have been paid or liquidated.
5. Our total liability hereunder shall not exceed the Guaranteed Sum of:  
.....  
.....Rand (in words);  
R..... (in figures)
6. The Guarantor reserves the right to withdraw from this Guarantee by depositing the Guaranteed Sum with the

beneficiary, whereupon our liability hereunder shall cease.

7. We hereby choose our address for the serving of all notices for all purposes arising here from as

.....  
.....  
.....  
.....

IN WITNESS WHEREOF this Guarantee has been executed by us at .....  
on this ..... day of ..... 26 .....

Signature .....

Duly authorized to sign on behalf of .....

Address .....  
.....  
.....

As witnesses:

1 .....

2 .....

---

**MPUMALANGA DEPARTMENT OF AGRICULTURE, RURAL DEVELOPMENT LAND, AND ENVIRONMENTAL AFFAIRS**

**RIVER ABSTRACTION PUMP STATION WITH WATER TREATMENT PLANT FOR INKANYEZI POULTRY FARM IN CALM, GERT SIBANDE DISTRICT**

**C1.4: AGREEMENT IN TERMS OF SECTION 37(2) OF THE OCCUPATIONAL HEALTH AND SAFETY ACT NO 85 OF 1993**

THIS AGREEMENT is made between **The MPUMALANGA DEPARTMENT OF AGRICULTURE, RURAL DEVELOPMENT, LAND AND ENVIRONMENTAL AFFAIRS** represented by the Municipal Manager

(hereinafter called the EMPLOYER of the one part, herein represented by:

.....  
in his capacity as: .....

AND: .....

(hereinafter called the CONTRACTOR) of the other part, herein represented by.....

.....  
in his capacity as: .....

duly authorised to sign on behalf of the Contractor.

WHEREAS the CONTRACTOR is the Mandatory of the EMPLOYER in consequence of an Agreement between the CONTRACTOR and the EMPLOYER in respect of

**PROJECT: RIVER ABSTRACTION PUMP STATION WITH WATER TREATMENT PLANT FOR INKANYEZI POULTRY FARM IN CALM, GERT SIBANDE DISTRICT**

**CONTRACT No: As per bid bulletin**

AND WHEREAS the EMPLOYER and the CONTRACTOR have agreed to enter into an agreement in terms of the provisions of Section 37(2) of the Occupational Health and Safety Act No 85 of 1993, as amended by OHS Act Amendment Act No 181/1993 (hereinafter referred to as the ACT);

**NOW THEREFORE** the parties agree as follows:

1. The CONTRACTOR undertakes to acquaint the appropriate officials and employees of the CONTRACTOR with all relevant provisions of the ACT and the regulations promulgated in terms thereof.
2. The CONTRACTOR undertakes to fully comply with all relevant duties, obligations and prohibitions imposed in terms of the ACT and Regulations: Provided that should the EMPLOYER have prescribed certain arrangements and procedures that same shall be observed and adhered to by the CONTRACTOR, his officials and employees. The CONTRACTOR shall bear the onus of acquainting himself/herself/itself with such arrangements and procedures.
3. The CONTRACTOR hereby accepts Sole Liability for such due compliance with the relevant duties, obligations, prohibitions, arrangements and procedures, if any, imposed by the ACT and Regulations, and the CONTRACTOR expressly absolves the EMPLOYER and the Employer's CONSULTING ENGINEERS from being obliged to comply with any of the aforesaid duties, obligations, prohibitions, arrangements and

procedures in respect of the work included in the Contract.

- 4. The CONTRACTOR agrees that any duly authorised officials of the EMPLOYER shall be entitled, although not obliged, to take such steps as may be necessary to ensure that the CONTRACTOR has complied with his undertakings as more fully set out in paragraphs 1 and 2 above, which steps may include, but shall not be limited to, the right to inspect any appropriate site or premises occupied by the CONTRACTOR, or to take such steps it may deem necessary to remedy the default of the CONTRACTOR at the cost of the CONTRACTOR.
  
- 5. The CONTRACTOR shall be obliged to report forthwith to the EMPLOYER any investigation, complaint or criminal charge which may arise as a consequence of the provisions of the ACT and Regulations, pursuant to work performed in terms of this agreement, and shall, on written demand, provide full details in writing of such investigation, complaint or criminal charge.

Thus signed at ..... For and on behalf of the CONTRACTOR

On this the ..... day of ..... 26.....

SIGNATURE: .....

NAME AND SURNAME: .....

CAPACITY: .....

WITNESSES: 1. ....

2. ....

Thus signed at ..... for and on behalf of the EMPLOYER on this

The ..... day of ..... 26.....

SIGNATURE: .....

NAME AND SURNAME: .....

CAPACITY: .....

WITNESSES: 1. ....

2. ....

## **PART C2: PRICING DATA**

### **C2.1: PRICING INSTRUCTIONS**

### **C2.2: BILL OF QUANTITIES**

## MPUMALANGA DEPARTMENT OF AGRICULTURE, RURAL DEVELOPMENT LAND AND ENVIRONMENTAL AFFAIRS

### RIVER ABSTRACTION PUMP STATION WITH WATER TREATMENT PLANT FOR INKANYEZI POULTRY FARM IN CALM, GERT SIBANDE DISTRICT.

#### C2.1 Pricing Instructions

1. Measurement and payment shall be in accordance with the relevant provisions of the General Conditions of Contract 2015 (3<sup>rd</sup> Edition) as amended in the Scope of Works.
2. The units of measurement described in this Bill of Quantities are metric units. Abbreviations used in the Bill of Quantities are as follows:

|                      |   |                       |
|----------------------|---|-----------------------|
| %                    | = | percent               |
| h                    | = | hour                  |
| ha                   | = | hectare               |
| kg                   | = | kilogram              |
| kl                   | = | kilolitre             |
| km                   | = | kilometre             |
| km-pass              | = | kilometre-pass        |
| kPa                  | = | kilopascal            |
| kW                   | = | kilowatt              |
| l                    | = | litre                 |
| m                    | = | metre                 |
| mm                   | = | millimetre            |
| m <sup>2</sup>       | = | square metre          |
| m <sup>2</sup> -pass | = | square metre-pass     |
| m <sup>3</sup>       | = | cubic metre           |
| m <sup>3</sup> -km   | = | cubic metre-kilometre |
| MPa                  | = | megapascal            |
| No.                  | = | number                |
| Prov sum             | = | Provisional sum       |
| PC sum               | = | Prime Cost sum        |
| R/only               | = | Rate only             |
| sum                  | = | lump sum              |
| t                    | = | ton (1000 kg)         |
| W/day                | = | Work day              |

3. For the purpose of this Bill of Quantities, the following words shall have the meanings hereby assigned to them:

|           |   |
|-----------|---|
| Unit:     | The unit of measurement for each item of work as defined in the Specifications  |
| Quantity: | The number of units of work for each item.  |
| Rate:     | The agreed payment per unit of measurement.   |
| Amount:   | The product of the quantity and the agreed rate for an item.  |
| Lump sum: | An agreed amount for an item, the extent of which is described in the Bills of Quantities but the quantity of work of which is not measured in any units. |

4. Unless otherwise stated, items are measured net in accordance with the Drawings, and no allowance is made for waste.
5. The prices and rates in this Bill of Quantities are fully inclusive prices for the Work described under the items. Such prices and rates cover all costs and expenses that may be required in and for the execution of the Work described in accordance with the provisions of the Scope of Work, and shall cover the cost of all general risks, liabilities, and obligations set forth or implied in the Contract Data, as well as overhead charges and profit. These prices will be used as a basis for assessment of payment for additional Work that may have to be carried out.

6. It will be assumed that prices included in the Bill of Quantities are based on Acts, Ordinances, Regulations, By-laws, International Standards and National Standards that were published 28 days before the closing date for Tenders. (Refer to [www.stanza.org.za](http://www.stanza.org.za) or [www.iso.org](http://www.iso.org) for information on Standards)
7. Where the Scope of Work requires detailed Drawings and designs or other information to be provided, all costs associated therewith are deemed to have been provided for and included in the unit rates and sum amount Tendered such items
8. An item against which no price is entered will be considered to be covered by the other prices or rates in the Bill of Quantities. A single Lump Sum will apply should a number of items be grouped together for pricing purposes.
9. The quantities set out in this Bill of Quantities are approximate and do not necessarily represent the actual amount of Work to be done. The quantities of work accepted and Certified for Payment will be used for determining payments due and not the quantities given in this Bill of Quantities.
10. The short descriptions of the items of payment given in this Bill of Quantities are only for the purposes of identifying the items. More details regarding the extent of the work entailed under each item appear in the Scope of Work.
11. The item numbers appearing in the Bills of Quantities refer to the corresponding item numbers in the Specifications were applicable.
12. Those parts of the contract to be constructed using labour-intensive methods have been marked in the Bills of Quantities with the letters "LI" in a separate column filled in against every item so designated. The works, or parts of the works so designated are to be constructed using labour-intensive methods only. The use of plant to provide such works, other than plant specifically provided for in the scope of work, is a variation to the contract. The items marked with the letters LI are not necessarily an exhaustive list of all the activities which must be done by hand, and this clause does not over-ride any of the requirements in the generic labour intensive specification in the Scope of Works.
13. Payment for items which are designated to be constructed labour-intensively (either in this schedule or in the Scope of Works) will not be made unless they are constructed using labour-intensive methods. Any unauthorised use of plant to carry out work which was to be done labour-intensively will not be condoned and any works so constructed will not be certified for payment.

**NB: For pricing of items for which description in the BoQ differs from that of the specifications; the description in the specifications shall take precedence.**

## C2.2 Bill of Quantities

| TREATMENT PLANT FOR INKANYEZI POULTRY FARM<br>IN CALM, GERT SIBANDE DISTRICT |                        |   |        | SECTION A:PRELIMINARY AND<br>GENERALS |      |               |
|--|------------------------|---|--------|---------------------------------------|------|---------------|
| Item No  | Payment<br>Clause      | Short Description   | Unit   | Quantity                              | Rate | Amount<br>R c |
| A1   | SANS<br>1200A          | <b>PRELIMINARY AND GENERAL</b>  |        |                                       |      |               |
|  |                        | <b>Fixed-charge Items</b>   |        |                                       |      |               |
| A1.1   | 8.3.1                  | Contractual requirements  | Sum    | 1                                     |      |               |
| A1.2   | 8.3.2                  | Establishment of Facilities on Site for:  |        |                                       |      |               |
| A1.2.2   |                        | The Contractor  | Sum    | 1                                     |      |               |
|  | 8.3.3                  | Other fixed-charge obligations  |        |                                       |      |               |
| A1.3   | SD7<br>8.3.4           | Removal of Site establishment on completion.  | Sum    | 1                                     |      |               |
| A1.4   |                        | <b>Environmental Management:</b>  |        |                                       |      |               |
| A1.4.1   |                        | Compliance with environmental management specification                                    | Sum    | 1                                     |      |               |
| A1.4.2   |                        | Environmental awareness training  | Sum    | 1                                     |      |               |
| A1.5   | SPEC AO                | <b>Health and safety:</b>   |        |                                       |      |               |
| A1.5.1   |                        | General safety obligations  | Sum    | 1                                     |      |               |
| A1.5.2   |                        | Risk assessment   | Sum    | 1                                     |      |               |
| A1.5.3   |                        | Health and safety plan  | Sum    | 1                                     |      |               |
| A1.5.4   |                        | Safety officer and other appointments   | Sum    | 1                                     |      |               |
| A1.5.5   |                        | Training  | Sum    | 1                                     |      |               |
| A1.6   | SANS<br>1200A<br>8.3.4 | Removal of site establishment and reinstatement of site on completion                     | Sum    | 1                                     |      |               |
| A2   |                        | <b>Time-related Items</b>   |        |                                       |      |               |
| A2.1   | 8.4.1                  | Contractual requirements  | months | 8                                     |      |               |
| A2.2   | 8.4.2                  | <b>Operation and Maintenance of Facilities on Site, for duration of construction for:</b> |        |                                       |      |               |
| A2.2.2   | 8.4.2.2                | The Contractor  | months | 8                                     |      |               |
| A2.4   | 8.4.4                  | Company and head office overhead costs for duration of construction                       | months | 8                                     |      |               |
| A2.5   | 8.4.5                  | Other time-related obligations  | months | 8                                     |      |               |
| A.2.6  |                        | <b>Health and safety:</b>   |        |                                       |      |               |
| A.2.7  |                        | General safety obligation   | months | 8                                     |      |               |
| A.2.8  |                        | Health and safety plan  | months | 8                                     |      |               |
| A.2.9  |                        | Construction safety officer and other appointments  | months | 8                                     |      |               |
| <b>Carried forward / ...</b>   |                        |   |        |                                       |      | <b>R</b>      |

| TREATMENT PLANT FOR INKANYEZI POULTRY FARM IN CALM, GERT SIBANDE DISTRICT |                |  |                 | SECTION A:PRELIMINARY AND GENERALS |             |             |
|---|----------------|--|-----------------|------------------------------------|-------------|-------------|
| Item No   | Payment Clause | Short Description  | Unit            | Quantity                           | Rate        | Amount R c  |
| A3  | 8.5            | Brought forward / ...<br><b>Sums stated provisionally by the Engineer</b>  |                 |                                    |             |             |
| A3.1  | 8.8.4          | Alterations to existing services   |                 |                                    |             |             |
| A3.1.1  | 8.8.3          | Location, protection, or alteration and relocation of existing services carried by Authorities/other Contractors | Provisional Sum | 1                                  | R 15,000.00 | R 15,000.00 |
| A3.1.2  |                | Percentage adjustment to item A3.1.1 For Contractors overheads and profit (State % and extend as an amount)      | %               |                                    |             |             |
| A4  |                | <b>Daywork</b>   |                 |                                    |             |             |
| A4.1  |                | Labour   |                 |                                    |             |             |
| A4.1.1  |                | Skilled labour   | Hrs             | 120                                |             |             |
| A4.1.2  |                | Semi-skilled labour  | Hrs             | 160                                |             |             |
| A4.1.3  |                | Unskilled labour   | Hrs             | 160                                |             |             |
| A4.2  |                | Materials  |                 |                                    |             |             |
| A4.2.1  |                | Allow for net cost of goods or materials actually used   | Provisional Sum | 1                                  | R 20,000.00 | R 20,000.00 |
| A4.2.2  |                | Percentage mark-up on Item A6.2.1 (State % and extend as an amount)  | %               |                                    |             |             |
|   |                | Contractor's own plant on Site   |                 |                                    |             |             |
| A4.3  |                | <b>Plant hired by Contractor</b>   |                 |                                    |             |             |
| A4.3.1  |                | Allow for net cost of hired plant  | Provisional Sum | 1                                  | R 30,000.00 | R 30,000.00 |
| A4.3.2  |                | Percentage mark-up on Item A6.4.1 (State % and extend as an amount)  | %               |                                    |             |             |
| A5  | 8.5            | <b>SUMS STATED PROVISIONALLY BY ENGINEER</b>   |                 |                                    |             |             |
| A5.1  |                | (a) Testing by the Engineer  | sum             | 1                                  |             |             |
| A5.2  |                | (b) Community liason officer   | sum             | 1                                  |             |             |
| A5.4  |                | (c) Lab equipment,signage and tools  | sum             | 1                                  |             |             |
| A5.5  |                | (d) Environmental Control Officer  | month           | 8                                  |             |             |
| A5.6  |                | e) Contractors markup to item A5.1 to A5.6   | %               |                                    |             |             |
| <b>TOTAL SECTION A: Carried to Summary</b>                                |                |  |                 |                                    | <b>R</b>    |             |

| PLANT FOR INKANYEZI POULTRY FARM IN CALM, GERT SIBANDE DISTRICT |                |  |                |          | SECTION B:SITE CLEARANCE |            |
|---|----------------|--|----------------|----------|--------------------------|------------|
| Item No   | Payment Clause | Short Description  | Unit           | Quantity | Rate                     | Amount R c |
| <b>SITE CLEARANCE AND EARTHWORKS</b>                            |                |  |                |          |                          |            |
| B1  | SANS 1200 C    | Site Clearance   |                |          |                          |            |
| B1.1  | 8.2.1          | Clear and grub site including trees up to 1m girth   | ha             | 2        |                          |            |
| B1.2  | 8.2.2          | <b>Remove and grub large trees and tree stumps of girth:</b>   |                |          |                          |            |
| B1.3  |                | <b>over 1m and up to and including 2m</b>  | No.            |          |                          |            |
| B1.4  | 8.2.4          | Reclear surface (only on instructions from the Engineer)   | ha             | 0.5      |                          |            |
| B1.5  | 8.2.5          | Take down existing fences and reinstate on completion  | m              | 200      |                          |            |
| B1.6  | 8.2.7          | Dismantle and remove pipelines, electricity transmission lines, cables   |                |          |                          |            |
| B1.6.1  |                | 150 mm dia sewer pipes   | m              | 10       |                          |            |
| B1.6.2  |                | 100 mm dia water pipes   | m              | 10       |                          |            |
| B1.7  | 8.2.10         | Remove topsoil to a nominal depth of 150mm stockpile   | m <sup>2</sup> | 1,200    |                          |            |
| B1.8  | 8.2.10         | Remove topsoil to a nominal depth of 150mm on pipeline routes  | m <sup>2</sup> | 800      |                          |            |
| B2  | SANS 1200 D    | <b>Excavation</b>  |                |          |                          |            |
| B2.1  | 8.3.2          | <b>Bulk excavation</b>   |                |          |                          |            |
| B2.1.1  |                | Excavate in all materials and use for embankment or backfill or dispose, as ordered by the Engineer.                               | m <sup>3</sup> | 550      |                          |            |
| B2.2  | 8.3.3          | <b>Restricted Excavation</b>   |                |          |                          |            |
|   |                | <b>Excavate for restricted foundations and footings in all materials and use for embankment or backfill or dispose, as ordered</b> |                |          |                          |            |
| B2.2.1  |                | Abstraction works  | m <sup>3</sup> | 400      |                          |            |
| B2.2.2  |                | Miscellaneous structures   | m <sup>3</sup> | 40       |                          |            |
| B2.3  |                | Extra-over item B2.2 for hard rock   | m <sup>3</sup> | 110      |                          |            |
| <b>Carried forward / ...</b>                                    |                |  |                |          |                          | <b>R</b>   |
| <b>Brought forward / ...</b>                                    |                |  |                |          |                          |            |

| PLANT FOR INKANYEZI POULTRY FARM IN CALM, GERT SIBANDE DISTRICT |                |   |                | SECTION B:SITE CLEARANCE |          |               |
|---|----------------|---|----------------|--------------------------|----------|---------------|
| Item No   | Payment Clause | Short Description   | Unit           | Quantity                 | Rate     | Amount<br>R c |
| B2.4  |                | Extra excavation  |                |                          |          |               |
| B2.4.1  | 8.3.5          | Excavation in all materials to provide working space around structures              | m <sup>2</sup> | 800                      |          |               |
| B2.4.2  |                | Excavation unsuitable material  | m <sup>3</sup> | 360                      |          |               |
| B2.5  | 8.3.9          | Extra over item B2.4 for approved granular material for backfill against structures | m <sup>3</sup> | 100                      |          |               |
| B2.6  | 8.3.9          | Compacted fill under structures   | m <sup>3</sup> | 100                      |          |               |
| B3  | SANS 1200 DB   | <b>Finishing</b>  |                |                          |          |               |
| B3.1  | 8.3.6.1        | Reinstate topsoil to a minimum thickness of 100mm                                   | m <sup>2</sup> | 800                      |          |               |
| B3.2  | 8.3.6.1        | Reinstate road surfaces complete with all courses                                   | m <sup>2</sup> | 20                       |          |               |
| <b>TOTAL SECTION B: Carried to Summary</b>                      |                |   |                |                          | <b>R</b> |               |

| RIVER ABSTRACTION PUMP STATION WITH WATER TREATMENT<br>PLANT FOR INKANYEZI POULTRY FARM IN CALM, GERT SIBANDE |                       |   |                | SECTION C:ABSTRACTION<br>WORKS |      |               |
|---|-----------------------|---|----------------|--------------------------------|------|---------------|
| Item No   | Payment<br>Clause     | Short Description   | Unit           | Quantity                       | Rate | Amount<br>R c |
|   |                       | <b>ABSTRACTION WORKS AND PUMPSTATION</b>                                    |                |                                |      |               |
| C1  | <b>SANS<br/>1200G</b> | <b>Concrete work</b>  |                |                                |      |               |
| C1.1  | 8.2.1                 | <b>Formwork</b>   |                |                                |      |               |
|   |                       | <b>Rough:</b>   |                |                                |      |               |
| C1.1.1  |                       | Plane vertical to narrow widths ( up to 300mm)                              | m              | 120.0                          |      |               |
| C1.1.2  |                       | Plane vertical to wall  | m <sup>2</sup> | 600.0                          |      |               |
| C1.2  | 8.2.2                 | <b>Smooth:</b>  |                |                                |      |               |
| C1.2.1  |                       | Plane vertical to narrow widths ( up to 300mm)                              | m              | 50.0                           |      |               |
| C1.2.2  |                       | Plane vertical to wall  | m <sup>2</sup> | 600.0                          |      |               |
| C1.2.3  |                       | Plane horizontal to soffit of suspended slab (prop height over 3m up to 4m) | m <sup>2</sup> | 6.0                            |      |               |
| C1.3  | 8.2.6                 | <b>Box Out Holes/Form Voids</b>   |                |                                |      |               |
| C1.3.1  |                       | 500 x 500mm opening on wall (up to 300mm thick)                             | No.            | 10.0                           |      |               |
| C2  |                       | <b>Reinforcement:</b>   |                |                                |      |               |
| C2.1  | 8.3.1                 | <b>Mild Steel Bars:</b>   |                |                                |      |               |
| C2.1.1  |                       | Up to 10mm dia  | t              | 1.0                            |      |               |
| C2.2  | 8.3.1                 | <b>High Tensile Bars:</b>   |                |                                |      |               |
| C2.2.1  |                       | 10mm dia  | t              | 2.0                            |      |               |
| C2.2.2  |                       | 12mm dia  | t              | 4.0                            |      |               |
| C2.2.3  |                       | 16mm Fia  | t              | 6.0                            |      |               |
| C2.2.4  |                       | 20mm dia  | t              | 12.0                           |      |               |
| C3  |                       | <b>Concrete</b>   |                |                                |      |               |
| C3.1  | 8.4.3                 | <b>Strength Concrete: 15MPa/19mm to:</b>                                    |                |                                |      |               |
| C3.1.1  |                       | Blinding (75mm thick)   | m <sup>2</sup> | 45.0                           |      |               |
| C3.1.2  |                       | Benching  | m <sup>3</sup> | 5.0                            |      |               |
| C3.2  | 8.4.3                 | <b>Strength Concrete: 35MPa/19mm to:</b>                                    |                |                                |      |               |
| C3.2.1  |                       | Floor slab  | m <sup>3</sup> | 70.0                           |      |               |
| C3.2.2  |                       | Wall  | m <sup>3</sup> | 100.0                          |      |               |
| Carried forward / ...   |                       |   |                |                                |      |               |
| Brought forward / ...   |                       |   |                |                                |      |               |

| RIVER ABSTRACTION PUMP STATION WITH WATER TREATMENT PLANT FOR INKANYEZI POULTRY FARM IN CALM, GERT SIBANDE |                |  |                |          | SECTION C:ABSTRACTION WORKS |            |
|--|----------------|--|----------------|----------|-----------------------------|------------|
| Item No  | Payment Clause | Short Description  | Unit           | Quantity | Rate                        | Amount R c |
| C3.2.3   | SANS 1200G     | Suspended slab   | m <sup>3</sup> | 5.0      |                             |            |
| C3.3   | 8.4.4          | <b>Unformed Surface Finishes:</b>                                    |                |          |                             |            |
| C3.3.1   |                | Wood float to slabs  | m <sup>2</sup> | 120.0    |                             |            |
| C3.3.2   |                | Wood float to wall (up to 300mm wide)                                | m              | 60.0     |                             |            |
| C3.3.3   |                | Steel float  | m <sup>2</sup> | 100.0    |                             |            |
| C4   | 8.5            | <b>Joints</b>  |                |          |                             |            |
| C4.1   |                | Type W48 (Horizontal wall joint)                                     | m              | 140.0    |                             |            |
| C5   | 8.7            | <b>Grouting</b>  |                |          |                             |            |
| C6   |                | <b>Pipework</b>  |                |          |                             |            |
| C6.1   |                | Supply and cast in 110mm dia stainless steel puddle pipe, 800mm long | No.            | 4.0      |                             |            |
| C6.2   |                | 110mm dia uPVC flexible lyng coupling                                | No.            | 3.0      |                             |            |
| C6.3   |                | 110mm dia end cap suitable for steel pipe                            | No.            | 1.0      |                             |            |
| C6.4   |                | Supply and cast in 160mm dia stainless steel puddle pipe, 800mm long | No.            | 4.0      |                             |            |
| C6.5   |                | 160mm dia uPVC flexible lyngcoupling                                 | No.            | 3.0      |                             |            |
| C6.6   |                | 160mm dia end cap suitable for steel pipe                            | No.            | 1.0      |                             |            |
| C7   | 1200HA         | <b>Metalwork</b>   |                |          |                             |            |
| C7.1   |                | Supply and install galvanised handrails complete side mounted on:    |                |          |                             |            |
| C7.1.1   |                | Horizontal surface complete  | m              | 20.0     |                             |            |
| C7.1.2   |                | Sloping surface complete   | m              | 5.0      |                             |            |
| C7.2   |                | Extra over to Item D8.1 for:   |                |          |                             |            |
| C7.2.1   |                | Bends  | No.            | 10.0     |                             |            |
| C7.2.2   |                | Ends   | No.            | 5.0      |                             |            |
| C8   |                | <b>Miscellaneous</b>   |                |          |                             |            |
|  |                | Supply and install Stainless Steel ladder as shown on drawings.      | No             | 2.0      |                             |            |
| C9   |                | Supply and install grp grating as shown on drawings.                 | m <sup>2</sup> | 60.0     |                             |            |
| C10  |                | Dealing with water during construction                               | Sum            | 1.0      |                             |            |
| <b>Carried forward / ...</b>   |                |  |                |          |                             |            |
| <b>Brought forward / ...</b>   |                |  |                |          |                             |            |

| RIVER ABSTRACTION PUMP STATION WITH WATER TREATMENT<br>PLANT FOR INKANYEZI POULTRY FARM IN CALM, GERT SIBANDE |                   |  |      |          | SECTION C:ABSTRACTION<br>WORKS |               |
|---|-------------------|--|------|----------|--------------------------------|---------------|
| Item No   | Payment<br>Clause | Short Description  | Unit | Quantity | Rate                           | Amount<br>R c |
| Carried forward / ...   |                   |  |      |          |                                |               |
| Brought forward / ...   |                   |  |      |          |                                |               |
| C11   |                   | <b>PUMPING EQUIPMENT</b><br>Pumps complete as specified, including cable,<br>guide rails, associated manifold piping and<br>accessories,etc. |      |          |                                |               |
| C11.1   | SPEC T/AT<br>8.3  | Supply pumps (H=54, Q=3.69l/s)   | No   | 2        |                                |               |
| C11.2   | SPEC T/HP<br>8    | Corrosion protection and painting  | No   | 2        |                                |               |
| C11.3   | SPEC T/AT<br>8.5  | Installation, testing and commissioning  | No   | 2        |                                |               |
| C11.4   |                   | <b>Watertightness testing:</b><br>Pump stations  | No.  | 1.0      |                                |               |
| <b>TOTALSECTION C:CARRIED TO SIMMARY</b>  |                   |  |      | <b>R</b> |                                |               |

| RIVER ABSTRACTION PUMP STATION WITH WATER TREATMENT PLANT FOR INKANYEZI POULTRY FARM IN CALM, GERT SIBANDE DISTRICT |                |  |                |          | SECTION D: PIPEWORK |            |
|---|----------------|--|----------------|----------|---------------------|------------|
| Item No   | Payment Clause | Short Description  | Unit           | Quantity | Rate                | Amount R c |
|   |                | <b>MEDIUM PRESSURE PIPEWORK</b>  |                |          |                     |            |
|   | SANS 1200 DB   | <b>Pipe Trench Earthworks</b>  |                |          |                     |            |
| D1  |                | <b>Excavation</b>  |                |          |                     |            |
|   | 8.3.2          | Excavate in all materials for pipe trenches, backfill, compact and dispose of surplus material for sewer pipes of: |                |          |                     |            |
| D1.1  |                | <b>Over 110mm up to 315mm</b>  |                |          |                     |            |
|   |                | <b>Over and Up to</b>  |                |          |                     |            |
| D1.1.1  |                | 0,5 m 1,5 m  | m              | 700.0    |                     |            |
| D1.1.2  |                | 1,5 m 2,5 m  | m              | 50.0     |                     |            |
| D1.1.3  |                | 2,5 m 3,5 m  | m              | 30.0     |                     |            |
| D1.2  |                | <b>Over 50mm up to 110mm</b>   |                |          |                     |            |
|   |                | <b>Over and Up to</b>  |                |          |                     |            |
| D1.2.1  |                | 0,5 m 1,5 m  | m              | 100.0    |                     |            |
| D1.2.2  |                | 1,5 m 2,5 m  | m              | 20.0     |                     |            |
| D1.2.3  |                | 2,5 m 3,5 m  | m              | 10.0     |                     |            |
| D1.4  |                | Extra-over itme G1.1 and G1.2 for hard rock  | m <sup>3</sup> | 200.0    |                     |            |
| D1.5  |                | Excavate and dispose unsuitable material from trench bottom  | m <sup>3</sup> | 150.0    |                     |            |
| D2  |                | <b>Excavation Ancillaries</b>  |                |          |                     |            |
| D2.1  |                | Extra compaction in road reserves  | m <sup>3</sup> | 50.0     |                     |            |
| D2.2  |                | Existing services that intersect a pipe trench   | No.            | 7.0      |                     |            |
|   | SANS 1200 LB   | <b>Pipe Bedding</b>  |                |          |                     |            |
| D3  |                | <b>Provision of bedding from:</b>  |                |          |                     |            |
| D3.1  | 8.2.1          | <b>Trench excavation:</b>  |                |          |                     |            |
| D3.1.1  |                | Selected fill material   | m <sup>3</sup> | 20.0     |                     |            |
| D3.1.1  |                | Selected granular material   | m <sup>3</sup> | 20.0     |                     |            |
| D3.2  | 8.2.2.1        | Other source on site:  |                |          |                     |            |
| D3.2.1  |                | Selected granular material   | m <sup>3</sup> | 50.0     |                     |            |
| D3.2.2  |                | Selected fill material   | m <sup>3</sup> | 50.0     |                     |            |
| <b>Carried forward / ...</b>  |                |  |                |          |                     |            |

| RIVER ABSTRACTION PUMP STATION WITH WATER TREATMENT PLANT FOR INKANYEZI POULTRY FARM IN CALM, GERT SIBANDE DISTRICT |                    |   |                | SECTION D: PIPEWORK |      |            |
|---|--------------------|---|----------------|---------------------|------|------------|
| Item No   | Payment Clause     | Short Description   | Unit           | Quantity            | Rate | Amount R c |
| <b>Brought forward / ...</b>  |                    |   |                |                     |      |            |
| D3.3  | 8.2.2.3            | <b>Commercial source:</b>   |                |                     |      |            |
| D3.3.1  |                    | Selected granular material  | m <sup>3</sup> | 100.0               |      |            |
| D3.3.2  |                    | Selected fill material  | m <sup>3</sup> | 200.0               |      |            |
| D4  | SANS 1200 LD 8.2.1 | <b>Supply, lay, joint, bed and test pipeline with flexible joints:</b>  |                |                     |      |            |
| D4.1  |                    | <b>Class C bed (SANS 1200LB Drawing LB-3)</b>   |                |                     |      |            |
| D4.1.1  |                    | 110mm dia PVC class 12  | m              | 700                 |      |            |
| D4.1.2  |                    | 160mm dia PVC class 12  | m              | 50                  |      |            |
| D4.2  | 8.2.2              | <b>Extra over item 4.1 for providing and installing fittings, valves and specials including all jointing material and hot dipped galvanised bolts, washers and nuts-To be supplied by the Contractor</b>  |                |                     |      |            |
|   |                    | <b>PVC Pipe junctions:</b>  |                |                     |      |            |
| D4.2.1  |                    | 110mm dia x 110mm dia Y-juction   | No.            | 4.0                 |      |            |
| D4.2.2  |                    | 110mm T-juction   | No.            | 3.0                 |      |            |
| D4.2.3  |                    | 110mm Cross T-juction<br>Bends:   | No.            | 5.0                 |      |            |
|   |                    | <b>Bends</b>  |                |                     |      |            |
| D4.2.4  |                    | 110mm dia x 11.25° PVC  | No.            | 2.0                 |      |            |
| D4.2.5  |                    | 110mm dia x 22.5° PVC   | No.            | 5.0                 |      |            |
| D4.2.6  |                    | 110mm dia x 45° PVC   | No.            | 5.0                 |      |            |
| D4.2.7  |                    | 110mm dia x 90° PVC   | No.            | 4.0                 |      |            |
|   |                    | <b>Resilient Seal Gate Valve (RSV), with Non-Rising Spindle Cap Top (AVK/AINSWORTH/BELGICAST) or similar approved, flanged and drilled. Resilient Seal Gate Valves complying with SANS 664, double flanged and drilled to SANS1123: 1977 Table 1600 for follwing diameters:</b> |                |                     |      |            |
| D4.2.8  |                    | DN110 mm  | No             | 5                   |      |            |
| <b>Carried forward / .....</b>  |                    |   |                |                     |      |            |

| RIVER ABSTRACTION PUMP STATION WITH WATER TREATMENT<br>PLANT FOR INKANYEZI POULTRY FARM IN CALM, GERT SIBANDE<br>DISTRICT |                   |  |                |          | SECTION D: PIPEWORK |               |
|---|-------------------|--|----------------|----------|---------------------|---------------|
| Item No   | Payment<br>Clause | Short Description  | Unit           | Quantity | Rate                | Amount<br>R c |
| <b>Brought forward /.....</b>   |                   |  |                |          |                     |               |
|   |                   | <b>Air Valves</b>  |                |          |                     |               |
|   |                   | Double Orifice Air control valves of the the type "Vent-O-Mat" Type 2 air release and vacuum break valve complete with "Anti-shock" and over pressure safety feature Series RBX flange studded to SANS 545, 2010, 304 stainless steel barrel and mild steel fusion bonded epoxy coated ends including Hot dipped galvanised Mild Steel nuts and washers and 1No. CAF ring gasket." Sizes less than DN80 mm shall be in accordance with SANS 62-2 |                |          |                     |               |
| D4.2.9  |                   | DN110 mm   | No             | 3        |                     |               |
| D4.2.10   |                   | DN80 mm  | No             | 2        |                     |               |
|   |                   | <b>Hydrants</b>  |                |          |                     |               |
| D4.2.11   |                   | DN110mm  | No             | 7        |                     |               |
| D4.2.12   |                   | DN80 mm  | No             | 4        |                     |               |
|   |                   | <b>Ball Valves</b>   |                |          |                     |               |
| D4.2.13   |                   | DN20 mm  | No             | 3        |                     |               |
|   |                   | <b>Reducers</b>  |                |          |                     |               |
| D4.2.14   |                   | DN110/90 mm  | No             | 1        |                     |               |
| D4.2.15   |                   | DN160/110 mm   | No             | 3        |                     |               |
|   |                   | <b>Non-Return (Check) Valves</b>   |                |          |                     |               |
| D4.2.16   |                   | 90 mm diameter   | No             | 2        |                     |               |
| D4.2.17   |                   | 110 mm diameter  | No             | 3        |                     |               |
|   |                   | <b>Encasement of pipes with:</b>   |                |          |                     |               |
| D4.3  |                   | Class 20/19 concrete   | m <sup>3</sup> | 10       |                     |               |
|   |                   | <b>Thrust Blocks</b>   |                |          |                     |               |
| D4.4  |                   | Class 20/19 concrete   | m <sup>3</sup> | 10       |                     |               |
|   |                   | <b>Valve chambers complete for depth:</b>  |                |          |                     |               |
| D4.5.1  |                   | 0 - 2.5m   | No             | 6        |                     |               |
| D4.5.2  |                   | 2.5m -3.5m   | No             | 1        |                     |               |
|   |                   | <b>Sterilizing of pipelines:</b>   |                |          |                     |               |
| D4.6  |                   | 110 mm diameter  | m              | 3200     |                     |               |
| <b>TOTAL SECTION D:</b>   |                   |  |                |          |                     |               |
| <b>Carried to Summary</b>   |                   |  |                |          | <b>R</b>            |               |

| RIVER ABSTRACTION PUMP STATION WITH WATER TREATMENT PLANT<br>FOR INKANYEZI POULTRY FARM IN CALM, GERT SIBANDE DISTRICT |                   |   |                    | SECTION E:WATER<br>TREATMENT WORKS |              |               |
|--|-------------------|---|--------------------|------------------------------------|--------------|---------------|
| Item No  | Payment<br>Clause | Short Description   | Unit               | Quantity                           | Rate         | Amount<br>R c |
| <b>WATER TREATMENT WORKS</b>   |                   |   |                    |                                    |              |               |
| E1   |                   | <b>Water Treatment Works</b>  |                    |                                    |              |               |
| E1.1   |                   | Supply and install 100m <sup>3</sup> /day package plant   | Provisional<br>Sum | 1                                  | 1,500,000.00 | 1,500,000.00  |
| E1.2   |                   | Percentage mark-up on Item A6.4.1 (State %<br>and extend as an amount)                                  | %                  |                                    |              |               |
| E1.2   |                   | Supply and install 200m <sup>3</sup> /day Elevated steel tank<br>complete with pipework and 15m upstand | Sum                | 1.0                                |              |               |
| E2   | 8.2.2             | Sludge drying beds  |                    |                                    |              |               |
| E2.1   |                   | Construct sludge drying beds as shown on<br>drawings  | No                 | 2.0                                |              |               |
| <b>TOTAL SECTION E:<br/>Carried to Summary</b>   |                   |   |                    |                                    |              | <b>R</b>      |

**RIVER ABSTRACTION PUMP STATION WITH WATER TREATMENT PLANT FOR INKANYEZI POULTRY FARM IN CALM, GERT SIBANDE DISTRICT**

**SECTION F: POWER SUPPLY FOR RIVER PUMP STATION**

**BILL NO. 1 : SUPPLY & DELIVERY OF MATERIAL AND LABOUR FOR LV RETICULATION**

| ITEM   | Applicable Drawings | DESCRIPTION  | UNIT | QTY | RATE |         | TOTAL (RANDS) |
|--|---------------------|--|------|-----|------|---------|---------------|
|  |                     |  |      |     | MAT. | INSTAL. |               |
| <b>F1.1</b>  |                     | <b>Conductor</b>   |      |     |      |         |               |
| F1.1.1   |                     | Supply, deliver and install 70mm <sup>2</sup> x 3 core + 1 x 50mm <sup>2</sup> insulated neutral Aerial Bunndle Conductor 600/1000V (Steel Reinforced with insulated neutral) to SABS 1418 | m    | 650 |      |         |               |
| <b>F1,2</b>  |                     | <b>Digging holes</b>   |      |     |      |         |               |
| F1.2.1   | D-DT0330            | 9m pole (1.5m deep) -Class 1 soft soil per hole (by hand)  | each | 6   |      |         |               |
| F1.2.2   | D-DT0330            | 9m pole (1.5m deep) - Class 2 pickable soil per hole (including rock and boulders)   | each | 2   |      |         |               |
| F1.2.3   | D-DT0330            | 9m pole (1.5m deep) - Hard Rock  | each | 3   |      |         |               |
| F1.2.4   | D-DT0330            | LV Stay Back-Actor or Hand - Class 1 soft soil per hole (by hand)  | each | 3   |      |         |               |
| F1.2.5   | D-DT0330            | LV Stay -Hard Rock hole  | each | 2   |      |         |               |
| <b>F1,3</b>  |                     | <b>Plant Wooden Poles &amp; Backfill</b>   |      |     |      |         |               |
| F1.3.1   |                     | 9m Wooden Pole 140-160mm top diameter  | each | 11  |      |         |               |
| <b>F1,4</b>  |                     | <b>Assemble and Install LV Structures</b>  |      |     |      |         |               |
|  |                     | <b>Three Phase LV Structures</b>   |      |     |      |         |               |
| F1.4.1   | D-DT-1100           | Suspension Assembly - (0 - 30) deg   | each | 8   |      |         |               |
| F1.4.2   | D-DT-1122           | Strainer - Assembly (60 - 90) deg  | each | 2   |      |         |               |
| F1.4.3   | D-DT-1120           | Terminal Assembly  | each | 1   |      |         |               |
| F1.4.4   | D-DT-1142           | T-Off from Strain  | each | 1   |      |         |               |
| <b>F1,5</b>  |                     | <b>Assemble and Install LV Stays and Struts</b>  |      |     |      |         |               |
| F1.5.1   | D-DT-0341           | Make-Off Conventional Stay (including 3/3.35mm staywire and hardware)  | each | 4   |      |         |               |
| <b>F1,6</b>  |                     | <b>LV Kiosk</b>  |      |     |      |         |               |
| F1.6.1   |                     | Supply and install IP65 rated pole mounted kiosk complete with the main breaker and breakers for the abstraction pumps   | Each | 1   |      |         |               |
| F1.6.2   |                     | Terminate the 70mm <sup>2</sup> 3C + Neutral ABC conductor at the LV Kiosk   | Each | 1   |      |         |               |
| <b>TOTAL SECTI0ON F CARRIED FORWARD TO SUMMARY</b> |                     |  |      |     |      |         |               |

**MPUMALANGA DEPARTMENT OF AGRICULTURE, RURAL DEVELOPMENT, LAND AND ENVIRONMENTAL AFFAIRS**

**RIVER ABSTRACTION PUMP STATION WITH WATER TREATMENT PLANT FOR INKANYEZI POULTRY FARM IN CALM, GERT SIBANDE DISTRICT**

**SUMMARY (TOTAL BID AMOUNT)**

| <b>SUMMARY OF SCHEDULE OF QUANTITIES</b> |                                     |              |
|--|-------------------------------------|--------------|
| <b>SECTION</b>                           | <b>DESCRIPTION</b>                  | <b>TOTAL</b> |
| <b>GENERAL</b>                           |                                     |              |
| A  | PRELIMINARY AND GENERAL             |              |
| B  | SITE CLEARANCE AND EARTHWORKS       |              |
| C  | ABSTRACTION WORKS AND PUMPSTATION   |              |
| D  | MEDIUM PRESSURE PIPELINES           |              |
| E  | WATER TREATMENT PLANT               |              |
| F  | POWER SUPPLY FOR RIVER PUMP STATION |              |
|  |                                     |              |
|  |                                     |              |

**SUBTOTAL**

**CONTIGENCIES 10%**

**SUBTOTAL**

**VAT @15%**

**TOTAL CARRIED TO FORM OF OFFER**

\_\_\_\_\_  
**DATE**

\_\_\_\_\_  
**SIGNATURE OF SERVICE PROVIDER**

**MPUMALANGA DEPARTMENT OF AGRICULTURE, RURAL DEVELOPMENT, LAND  
AND ENVIRONMENTAL AFFAIRS**

**RIVER ABSTRACTION PUMP STATION WITH WATER TREATMENT PLANT FOR  
INKANYEZI POULTRY FARM IN CALM, GERT SIBANDE DISTRICT**

**PART C3: SCOPE OF WORK**

**C3.1: STANDARD SPECIFICATIONS**

**C3.2: PROJECT SPECIFICATIONS**

**C3.3: PARTICULAR SPECIFICATIONS**

**MPUMALANGA DEPARTMENT OF AGRICULTURE, RURAL DEVELOPMENT, LAND AND ENVIRONMENTAL AFFAIRS**

**RIVER ABSTRACTION PUMP STATION WITH WATER TREATMENT PLANT FOR INKANYEZI POULTRY FARM IN CALM, GERT SIBANDE DISTRICT**

**C3: SCOPE OF WORK**

**C3.1 STANDARD SPECIFICATIONS**

**C3.2 PROJECT SPECIFICATIONS**

**PART A: GENERAL**

|       |                                       |
|-------|---------------------------------------|
| PS-1  | Project Description                   |
| PS-2  | Description of the Site and Access    |
| PS-3  | Details of the Works                  |
| PS-4  | Construction Programme                |
| PS-5  | Site Facilities Available             |
| PS-6  | Facilities Required on Site           |
| PS-7  | Management and Disposal of Water      |
| PS-8  | Rainfall Figures                      |
| PS-9  | Security Clearance of Personnel       |
| PS-10 | Health and Safety                     |
| PS-11 | Subcontractors                        |
| PS-12 | Deviation from Construction Programme |
| PS-13 | Delay in Completion                   |
| PS-14 | Supply of Materials                   |
| PS-15 | Execution of Works                    |
| PS-16 | Existing Services                     |
| PS-17 | Labour Intensive Specification        |

**PART B: AMENDMENTS TO THE STANDARD SPECIFICATIONS**

**C3.3 PARTICULAR SPECIFICATIONS**

- PART C: STANDARD SPECIFICATIONS FOR BUILDING TRADES**
- PART D: ENVIRONMENTAL MANAGEMENT**
- PART E: OHSA 1993 SAFETY SPECIFICATION**

**MPUMALANGA DEPARTMENT OF AGRICULTURE, RURAL DEVELOPMENT, LAND AND ENVIRONMENTAL AFFAIRS**

**RIVER ABSTRACTION PUMP STATION WITH WATER TREATMENT PLANT FOR INKANYEZI POULTRY FARM IN CALM, GERT SIBANDE DISTRICT**

**C3.1 STANDARD SPECIFICATIONS**

The standard specifications on which this contract is based are the SANS Standardised Specifications for Civil Engineering Works and the Conservation of Agricultural Resources Act (CARA) 43 of 1983.

All work shall comply with National, Provincial and Municipal legislation including the most current revision of the Occupational Health and Safety Act. The onus is on the Contractor to familiarize himself/herself with the relevant legislation and will be held responsible for any contravention by his/her employee/s

**MPUMALANGA DEPARTMENT OF AGRICULTURE, RURAL DEVELOPMENT, LAND AND ENVIRONMENTAL AFFAIRS**

**RIVER ABSTRACTION PUMP STATION WITH WATER TREATMENT PLANT FOR INKANYEZI POULTRY FARM IN CALM, GERT SIBANDE DISTRICT**

**C3.2: PROJECT SPECIFICATIONS**

**STATUS**

The Project Specification, consisting of two parts, forms an integral part of the contract and supplements the Standard Specifications.

Part A contains a general description of the works, the site and the requirements to be met.

Part B contains variations, amendments and additions to the Standardized Specifications and, if applicable, the Particular Specifications.

In the event of any discrepancy between a part or parts of the Standardized or Particular Specifications and the Project Specification, the Project Specification shall take precedence. In the event of a discrepancy between the Specifications, (including the Project Specifications) and the drawings and / or the Bill of Quantities, the discrepancy shall be resolved by the Engineer before the execution of the work under the relevant item.

The standard specifications which form part of this contract have been written to cover all phases of work normally required for road contracts, and they may therefore cover items not applicable to this particular contract.

## **PART A: GENERAL**

### **PS 1 PROJECT DESCRIPTION**

## **RIVER ABSTRACTION PUMP STATION WITH WATER TREATMENT PLANT FOR INKANYEZI POULTRY FARM IN CALM, GERT SIBANDE DISTRICT**

The standard specifications on which this contract is based are the SANS Standardised Specifications for Civil Engineering Works and the Conservation of Agricultural Resources Act (CARA) 43 of 1983.

All work shall comply with National, Provincial and Municipal legislation including the most current revision of the Occupational Health and Safety Act. The onus is on the Contractor to familiarize himself/herself with the relevant legislation and will be held responsible for any contravention by his/her employee/s.

The standard specifications on which this contract is based are the SANS Standardised Specifications for Civil Engineering Works.

The following SANS specifications are also referred to in this document and the Contractor is advised to obtain them from Standards South Africa (a division of SABS) in Pretoria.

|              |   |                                     |
|--------------|---|-------------------------------------|
| SABS 1200 A  | - | General (Small Works)               |
| SABS 1200 C  | - | Site Clearance (amended 1982)       |
| SABS 1200 DA | - | Earthworks (Small Works)            |
| SABS 1200 DB | - | Earthworks (Pipe Trenches)          |
| SABS 1200 GA | - | Concrete (Small Works)              |
| SABS 1200 H  | - | Structural Steelwork                |
| SABS 1200 HA | - | Structural Steelwork (Sundry Items) |
| SABS 1200 HB | - | Cladding and Sheeting               |
| SABS 1200 L  | - | Medium Pressure Pipe Lines          |
| SABS 1200 LB | - | Bedding (pipes)                     |

The following SANS specifications are also referred to in this document and the Contractor is advised to obtain them from Standards South Africa (a division of SABS) in Pretoria.

SANS 10396: 2003: Implementing Preferential Construction Procurement Policies using Targeted Procurement Procedures

SANS 1914-1 to 6 (2002): Targeted Construction Procurement

SANS 1921 – 1 (2004): Construction and Management Requirements for Works Contracts Part 1: General Engineering and Construction Works

and where accommodation of traffic is involved:

SANS 1921-2 (2004): Construction and Management Requirements for Works Contracts Part 2: Accommodation of Traffic on Public Roads Occupied by the Contractor.

## **THE SCOPE OF WORKS:**

The project consists of the construction of new Water abstraction works on the Komati River and the bulk pipeline from the Abstraction works to the Nkanyezi abattoir. The scope of works of this contract shall include:

- Construction of river abstraction station
- Construction of rising delivery pipeline
- Construction of the water treatment plant and reticulation to the abattoir and broiler houses

**NB: Items in Bill of Quantities are re-measurable, meaning contractor will only be paid for what is installed on site which will be measured by an Engineer on progress claims and final account, thus no wastage claim/s will be entertained. Therefore, contractor shall not use the items in Bill of Quantities to place equipment or materials orders and procurement but is expected to physically measure every actual material/s quantity required for the project prior to placing orders.**

The drawings listed in the index form an integral part of this specification.

## **PS 2 DESCRIPTIONS OF THE SITE AND ACCESS**

### **2.1 Location of site**

The coordinates for the site are as follows: -25.985923 S, 30.844564"E

Incidental intrusion into private property shall not be permitted without the owner's written authority. Any such agreement reached with a private landowner (occupier) shall include the proviso that any material or equipment on that site shall remain the exclusive property of the Employer in terms of the contract.

### **2.2 Access to site**

The coordinates for the site are as follows

-25.985923 S, 30.844564"E

The contractor shall be responsible for the maintenance and re-instatement of damage caused by him or his agents / deliveries during the construction activities. No damage to flora or fauna located outside the limits of the site will be permitted in this contract.

The contractor should take cognisance of the aforementioned items concerning the environment and allow for any costs in his bid under the relevant section in the Bill of Quantities.

## **PS 3 DETAILS OF THE WORKS**

All work shall be done by a bidder actively registered with the Department of Labour. The bidder shall provide certified copies as proof of accreditation and registration with the Department of Labour and voluntary association with this quotation and/or prior to being appointed and/or commencement of works at the site hand-over meeting and/or prior to commencement of any work. Such registration shall be active from project commencement to project completion and handover, failing this, the contractor will be stopped to work and be removed off site, at no client's costs.

Nkanyezi Farming (Pty) Ltd is in the process of establishing a broiler chicken facility on a farm within the Elukwatini Tribal Authority land in Gert Sibande District Municipality, Chief Albert Luthuli Local Municipality in the Mpumalanga

Province.

Nkanyezi Farm is located at the small town of Tjakastad, 33km from the town of Manzana (Badplaas) and about 6km from R541 in Mpumalanga Province. The study area lies adjacent to the Komati River, next to the Tjakastad Township of Chief Albert Luthuli Local Municipality in Mpumalanga Province. Nkanyezi farm is situated at about 12km away from Elukwatini Town (Enhlazatje) R541 with central co-ordinates are (-25.985923 S, 30.844564"E). The works shall include the following:

- a) Construction of an off-channel Abstraction works complete with a pump station
- b) Construction of a 110mm diameter uPVC pipeline Class 12 of length about 500m
- c) Construction of 100m<sup>3</sup>/day water treatment works (package plant)
- d) Construction of 200m<sup>3</sup> capacity Steel elevated water storage tank complete with upstands
- e) Construction of water reticulation pipelines
- f) Construction of roadworks
- i) Supply and laying of interconnecting pipework and associated structures for all the above mentioned structures.
- h) Electrical supply and MCC for all the abstraction works pump station

### **PS 3.29 Project Approach**

To provide all necessary transportation, supervision, labour, tools, equipment, services and expertise to apply to pruning and removal of trees as directed in the specifications. It is required of the service providers to provide the necessary equipment and crews to complete the work in the specific period. The Employer will appoint a consultant to monitor all the works for progress and quality. Regular progress payments, based on work actually performed at the Tendered rates, are envisaged.

### **PS3.30 Labour Recruitment Conditions**

A Project Steering Committee (PSC) will be established and is a vital means of communication between all parties involved with the project. The composition of the PSC comprises representation by the Employer, the Engineer and formal structures within the community.

The contractor shall make use of these communication channels, and shall appoint from amongst his site personnel a responsible person to participate in the affairs of the PSC, and this representative may be also required to attend the monthly PSC meetings.

It is mandatory that the Contractor shall interact with the community via proactive project liaison and project participation by its leaders and constituted organisations and forums, as well as through the employment of its people, and these activities shall constitute essential facets of the project.

Local labour is to be used and the employment of such labour is to be done in conjunction with the PSC/CLO.

PSC shall appoint a Community Liaison Officer (CLO). The duties of the CLO shall consist inter alias of the following:

- To be available on site daily between the hour of 07:00 and 17:00 and at other times as the need arises. His normal working day will extend from 07:00 in the morning until 17:00 in the afternoon.
- To communicate daily with regard to number and skills, to facilitate in labour disputes and to assist in their resolution.
- To attend all meetings in which the community and/or labour are present or are required to be represented.
- To attend all PSC meeting to report on labour.
- To assist in the identification and screening of labourers from the community in accordance with the

contractor's requirements.

- To advise and inform temporary labourers of their conditions of employment and to inform temporary labourers as early as possible when their period of employment will be terminated.
- To attend disciplinary proceedings to ensure that hearings are fair and reasonable.
- To keep a daily written record of his interviews and community liaison, labour force etc.
- To attend monthly site meetings and report in writing on labour and contract matters.
- Keeping a data base of available labour.
- All such other duties as agreed upon between all parties concerned.
- Compile a list of available skills in the area (skills audit).

## **PS 4 WORK PROGRAMME**

### **PS 4.1 General**

The submission of a work programme as stated per Clause 5 of the General Conditions of Contract is compulsory.

Before any work is to be commenced on the site (within a period as stated in Clause 5.6 of the General Conditions of Contract), the Contractor must submit a detailed project programme for the construction of the Works to the Engineer for his approval.

In preparation of the work programme the Contractor must liaise with the Engineer and the programme must take into account the coordination of all activities. The programme must consist of a detailed schedule or block diagram covering all aspects of the Works and the planned time thereof must, with the Contract Period as time basis, be shown.

Rainfall conditions will be taken as abnormal when the average rainfall, as shown in Clause PS 8, is exceeded and the contractor must then apply in writing for extension of the contract period using Clause 5.12 of the General Conditions of Contract.

The service provider is required to state in the Appendix to the Form of Tender the time in which he is prepared to undertake and complete the works.

The Contractor shall submit to the Engineer a realistic, detailed programme not later than 14 days after receipt of the Letter of Acceptance. The programme shall be in bar-chart format showing in detail how the Contractor proposes to complete the work covered by this contract by the Due Completion Date.

The following details must be stated:

- I. The quantity of work applicable to each bar item as well as the rate at which the work will be completed.
- II. A budget of the value of completed work, month by month, for the full contract period.
- III. The Contractor's plant commitment on the contract for every fortnight.
- IV. The critical path.

The programme shall be kept up to date. If a Contractor fails to maintain progress in terms of the programme, he shall produce a revised programme showing the modifications to the original programme necessary to ensure completion of the Works before the Due Completion Date.

The approval of any programme by the Engineer shall have no contractual significance, other than satisfying the Engineer that the Work is carried out according to such programme and that the Contractor undertakes to carry out the work in accordance with the programme. The Engineer will have the right to instruct the Contractor to revise the programme if necessitated by circumstances.

#### **PS 4.2 Time for Completion**

The maximum time allowed for the completion of the contract is **eight (8) months** (excluding special non-working days and the year end break) from the date of Letter of Acceptance / or Site Handover.

#### **PS 5 SITE FACILITIES AVAILABLE**

##### **PS 5.1 Water Supply**

The Service Provider must make his own arrangements for provision of fresh water on site for domestic and construction purposes.

The rates Tendered for the relevant items in the Preliminary and General Section of the schedule shall include all costs for the establishment and maintenance of water supply to the works and the Contractor shall make his own arrangements for the possible conveyance and storage of water if necessary.

##### **PS 5.2 Power Supply**

The Contractor must make his own arrangements for the provision of power on site. The rates Tendered for the relevant items in the Preliminary and General Section of the schedule shall include all costs for the establishment and maintenance of a power supply to the works.

#### **PS 6 FACILITIES REQUIRED ON SITE**

##### **PS 6.1 Facilities for the Engineer**

A site office for the Engineer is not required.

##### **PS 6.2 Facilities for the Contractor**

###### **Site Establishment**

The Service Provider is responsible to provide a suitable site for his camp and to provide accommodation for his personnel and labourers. If the Employer can make any specific site available to the Contractor, such site will be pointed out to the Contractor.

The chosen site shall be subject to the approval of the beneficiary/Engineer and the Project Steering Committee (if available). Possible locations for a campsite shall be pointed out at the Site inspection. The Contractor shall conform to all beneficiary, local authority, environmental and industrial regulations.

The Service Provider shall make his own arrangements concerning the supply of electrical power and all other services. No direct payment shall be made for the provision of electrical and other services. The cost thereof shall be deemed to be included in the rates and amounts Tendered for the various items of work for which these services are required.

The Contractor shall provide security watchmen for the contract as he deems fit at no extra cost for the Employer. The Contractor must ensure that all his employees as well as the employees of his subcontractors are able to identify themselves as members of the construction team.

###### **Ablution and Sanitary Facilities**

The Service Provider shall erect and maintain on the site proper ablution facilities. The Service Provider shall service and maintain the facilities in a clean and hygienic state for the duration of the contract period and on completion of the works remove it from the site to the satisfaction of the Employer/beneficiary.

##### **PS 6.3 Laboratory Facilities**

No laboratory facilities will be required for this work

**PS 6.4 Construction Notice Board (Name Board)**

1 Official Name Board per site, as per C4.2 Site Information: Construction Notice Board, is required for this contract.

**PS 6.5 Housing for the Engineer and/or his Representative**

No housing is required for the Engineer or his Representative.

**PS 6.6 Telephone Facilities**

Items have been provided in the Bill of Quantities to cover for communication costs for the Engineer.

**PS 7 MANAGEMENT AND DISPOSAL OF WATER**

The Contractor shall pay special attention to the management and disposal of water and storm water on the site. It is essential that all completed works or parts thereof are kept dry and properly drained. Claims for delay and for repair of damage caused to the works as a result of the Contractor's failure to properly manage rain and surface water, will not be considered.

**PS 8 RAINFALL FIGURES**

The following figures are applicable for Clause 50(5) of the Special Conditions of Contract:

INFORMATION SOURCE: WRC Report 1994

RAINFALL STATION:

PERIOD:

|                            |                      |                      |              |                      |                      |
|----------------------------|----------------------|----------------------|--------------|----------------------|----------------------|
| <b>Rainfall station:</b>   |                      |                      |              |                      |                      |
| <b>Period: 1938 – 2006</b> |                      |                      |              |                      |                      |
| <b>Month</b>               | <b>N<sub>n</sub></b> | <b>R<sub>n</sub></b> | <b>Month</b> | <b>N<sub>n</sub></b> | <b>R<sub>n</sub></b> |
| January                    |                      |                      | July         |                      |                      |
| February                   |                      |                      | August       |                      |                      |
| March                      |                      |                      | September    |                      |                      |
| April                      |                      |                      | October      |                      |                      |
| May                        |                      |                      | November     |                      |                      |
| June                       |                      |                      | December     |                      |                      |
| <b>Annual average:</b>     |                      |                      |              |                      |                      |

**N<sub>n</sub>** = Average amount of days on which a rainfall of 10 mm or more has been recorded.

**R<sub>n</sub>** = Average monthly rainfall in mm

Extensions of time in respect of Clause 5.12 in the General Conditions of Contract for Construction Works (2015) in respect of abnormal rainfall shall be calculated using the following formula for each calendar month or part thereof:

$$V = (N_w - N_n) + \frac{(R_w - R_n)}{X}$$

Where:

V = Extension of time in calendar days in respect of the calendar month under consideration.

N<sub>w</sub> = Actual number of days during the calendar month on which a rainfall of 10 mm or more has been recorded.

N<sub>n</sub> = Average number of days in the relevant calendar month, as derived from existing rainfall records,

on which a rainfall of 10mm or more has been recorded for the calendar month.  
Rw = Actual average rainfall in mm recorded for the calendar month under consideration.  
Rn = Average rainfall in mm for the calendar month as derived from existing rainfall records as stated in the Site Information.  
X = 20mm

For purposes of the Contract Nn, Rn and Nn shall have those values assigned to them in the table above based on figures from the WRC report 1994.

If V is negative and its absolute value exceeds Nn, then V shall be taken as equal to minus Nn.

The total extension of time shall be the algebraic sum of all monthly totals for the period under consideration, but if the total is negative the time for completion shall not be reduced due to subnormal rainfall. Extensions of time for part of a month shall be calculated using pro rata values of Nn and Rn.

This formula does not take account flood damage which could cause further or concurrent delays and will be treated separately as far as extension of time is concerned.

The factor (Nw – Nn) shall be considered to represent a fair allowance for variations from the average in the number of days during which rainfall exceeds 10 mm. The factor (Rw-Rn) shall be considered to represent a fair allowance for variations from the average in the number of days during which the rainfall did not exceed 10 mm but wet conditions prevented or disrupted work.

For the purpose of applying the formula, accurate rain gauging shall be taken at a suitable point on the Site and the Contractor shall at his own expense, take all necessary precautions to ensure that rain gauges cannot be interfered with by unauthorized persons.\

## **PS 9 SECURITY CLEARANCE OF PERSONNEL**

Service Providers to note that the Mpumalanga Department of Agriculture may require that Security Clearance investigations be conducted on any number of the service provider's personnel.

If so required, by the Mpumalanga Department of Agriculture, the service provider must remove personnel as indicated immediately and ensure that they have no access to the works or documentation or any other information pertaining to the site.

The Employer shall not be liable for any cost concerning the removal of personnel or the effect thereof on the execution of the work.

## **PS 10 HEALTH AND SAFETY**

### **PS 10.1 General statement**

It is a requirement of this contract that the Service Provider shall provide a safe and healthy working environment and to direct all his activities in such a manner that his employees and any other persons, who may be directly affected by his activities, are not exposed to hazards to their health and safety. To this end the Contractor shall assume full responsibility to conform to all the provisions of the Occupational Health and Safety Act (OHSA) No 85 and Amendment Act No 181 of 1993, and the OHSA 1993 Construction Regulations 2003 issued on 18 July 2003 by the Department of Labour. For the purpose of this contract the Contractor is required to confirm his status as mandatory and employer in his own right for the execution of the contract by entering into an agreement with the Employer in terms of the Occupational Health and Safety Act in the form as included in section C1.5.

### **PS 10.2 Health and Safety Specifications and Plans**

#### **(a) Employer's Health and Safety Specification**

The Employer's Health and Safety Specification is included in Section C3.3, Part E of the Tender documents as part of the Particular Specifications.

(b) Service Providers Health and Safety Plan

The service provider shall submit with the Tender his own documented Health and Safety Plan he proposes to be implemented for the execution of the work under the contract. The Health and Safety Plan must at least cover the following:

- (i) a proper risk assessment of the works, risk items, work methods and procedures in terms of Regulations 7 to 28;
- (ii) pro-active identification of potential hazards and unsafe working conditions;
- (iii) provision of a safe working environment and equipment;
- (iv) statements of methods to ensure the health and safety of subcontractors, employees and visitors to the site, including safety training in hazards and risk areas (*Regulation 5*);
- (v) monitoring health and safety on the site of works on a regular basis, and keeping of records and registers as provided for in the Construction Regulations;
- (vi) details of the Construction Supervisor, the Construction Safety Officers and other competent persons he intends to appoint for the construction works in terms of Regulation 6 and other applicable regulations; and
- (vii) details of methods to ensure that his Health and Safety Plan is carried out effectively in accordance with the Construction Regulations 2003.

The Contractor's Health and Safety Plan will be subject to approval by the Employer, or amendment if necessary, before commencement of construction work. The Contractor will not be allowed to commence work, or his work will be suspended if he had already commenced work, before he has obtained the Employer's written approval of his Health and Safety Plan.

Time lost due to delayed commencement or suspension of the work as a result of the Contractor's failure to obtain approval for his safety plan, shall not be used as a reason to claim for extension of time or standing time and related costs

### **PS 10.3 Cost of compliance with the OHSA Construction Regulations**

The rates and prices Tendered by the Contractor shall be deemed to include all costs for conforming to the requirements of the Act, the Construction Regulations and the Employer's Health and Safety Specification as applicable to this contract.

Should the Contractor fail to comply with the provisions of the Construction Regulations, he will be liable for penalties as provided in the Construction Regulations and in the Employer's Health and Safety Specification.

### **PS 11 SUBCONTRACTORS**

The Contractor shall have the right to cede any sub-contract under this contract to a subcontractor of his/her choice.

### **PS 12 DEVIATION FROM WORK PROGRAMME**

The programme of work as required in terms of the "General Conditions of Contract –Third Edition (2015)" shall be submitted to the Engineer not later than fourteen days after the Commencement Date.

The Contractor shall take into account the requirements of the Occupational Health and Safety Act, as well as the Construction Regulations in the drafting of the programme.

The format shall not be in the form of a bar chart only, but shall also clearly indicate the anticipated quantity of work to be executed each month. The construction programme shall also clearly indicate the local and

foreign labour to be utilised for the duration of the Contract.

If during the progress of the work, the quantities of the work performed per month fall below the expected indicated in the Construction programme, or if the sequence of operation is altered, or if the programme is deviated from in any other way, the Contractor shall, within one week after being notified by the Engineer, submit a revised construction programme.

Such a revised construction programme shall be based on the tempo of work achieved by the Contractor up to the date of revision. Any proposal to increase the tempo of work must be accompanied by positive steps to increase production by providing more labour and plant on site or by using the available labour and plant in a more efficient manner.

Failure on the part of the Contractor to work according to the programme or revised programmes shall be sufficient reason for the Engineer to take steps as provided for in the "General Conditions of Contract – Third Edition (2015)"

### **PS 13 DELAY IN COMPLETION**

The Service Provider shall organise the Works in such a manner that no delays occur. Delay due to faulty organisation or lack or shortage of materials or labour or co-operation with other parties or to any other cause within the control of the Contractor will not be countenanced and full power is reserved by the Engineer to order the Contractor to expedite the work should the work, in the opinion of the Engineer, not progress in a satisfactory way.

### **PS 14 SUPPLY OF MATERIALS**

All material to be used in the Works is to be supplied by the Contractor.

The Contractor shall ensure that the work is not delayed due to the lack of materials on Site, by placing orders for material required under this Contract as soon as possible. No extension of time will be allowed for any delay due to the supply of materials.

Although the quantities have been carefully calculated, it must be considered as approximate only and the Contractor, before ordering any materials, should check the quantities required. The bill of quantities is provisional.

### **PS 15 EXECUTION OF THE WORKS**

#### **PS 15.1 Inspection by the Engineer**

No portion of the work shall be proceeded with until the Engineer or his representative has examined and approved the previous stage. If any work is covered or hidden from view before the Engineer or his representative has inspected the work, the Contractor shall at his own cost expose the covered or hidden work for inspection. The Contractor shall also be responsible for making good any work damaged during the uncovering.

#### **PS 15.2 Certificate of Completion**

When all the work under the Contract have been completed to the entire satisfaction of the Engineer, he will issue a certificate of completion to the Contractor informing the Contractor of the date the date at which the works are deemed to be completed and accepted by the Employer.

The sureties provided by the Contractor for the fulfilment and completion of the Contract in terms of the Form of Agreement will be released upon the issue of the Certificate of Completion.

## **PS 16 EXISTING SERVICES**

The Contractor shall make himself acquainted with the position of all existing services before any excavation or other work likely to affect the existing services is commenced.

The Contractor will be held responsible for any damage to known existing services caused by or arising out of his operations and any damage shall be made good at his own expense. Damage to unknown services shall be repaired as soon as possible and liability shall be determined on site when such damage should occur.

A provisional amount is included in the bill of quantities for the protection and/or shifting of services.

Two weeks prior to commencing construction activities in a particular area, the Contractor shall also diligently enquire of local landowners as to whether there are any other known services which have not been shown on the drawings but which may be affected by the construction activities in that area, and any such services shall be brought to the attention of the Engineer immediately. The contractor shall make provision in his programme for the location and/or shifting of services.

The Contractor shall take note of the requirements of the standard specifications with regard to services.

## **PS 17 LABOUR INTENSIVE SPECIFICATIONS**

Labour must be used in all activities where such use of labour will not compromise quality and progress.

## **PART B: AMENDMENTS TO THE STANDARD SPECIFICATIONS**

### **B1 PROJECT SPECIFICATIONS RELATING TO THE STANDARD SPECIFICATIONS AND OTHER ADDITIONAL SPECIFICATIONS**

In certain clauses in the standard, standardised and particular specifications, allowance is made for a choice to be specified in the project specifications between alternative materials or methods of construction, and for additional requirements to be specified to suit a particular contract. Details of such alternative or additional requirements applicable to this contract are contained in this part of the project specifications. It also contains the necessary additional specifications required for this particular contract.

## **VARIATIONS TO REQUIREMENTS OF SPECIFICATIONS LISTED IN C3.1**

### **PS A GENERAL (SABS 1200A)**

#### **PS A1 REFERENCE PEGS**

The reference pegs placed by the Engineer may of necessity have to be moved during construction. Pegs that have to be moved must be properly referenced, recorded, marked and protected and later reinstated.

#### **PS A2 COMMENCING OF WORK**

Before commencing with the works, the contractor will check all dimensions, levels, sections and other data used for the calculation of quantities for payment purposes with the engineer. The contractor will inform the engineer before any new part of the work is started. If the contractor fails to follow the above steps, the decision of the engineer regarding dimensions, levels and sections will be final and no further negotiation will take place.

The submission of a Safety Plan and adherence to the safety requirements is a prerequisite for the start of the

works and the continuation thereof. The safety plan according to the specifications, which outlines in detail method statements how the works will be executed, all associated risks, risk assessments, appointments, appropriate medical fitness certificates, induction forms, CV's for all key personnel, etc. will be included. This Safety Plan must be submitted to the Employer for approval as well within 14 days after the Commencement Date

### **PS A3 ACCURACY OF WORK**

The contractor will execute the works according to the drawings and specifications as set out in this document, and drawings that will be issued during the construction period. Tolerances allowed will be as detailed or as specified in the relevant SABS specification. Any limitations and required / necessitated deviations in this regard must be cleared and approved by the engineer beforehand.

### **PS A4 CONTROL OF WORK**

The contractor must verify the quality of preparation and completion of all work and notify the engineer before he requests that an inspection be done. All equipment for the execution of tests (compaction, concrete, pressure testing and x-raying) must be supplied or arranged by the contractor. Application for inspections and/or approval of tests must be done on approved formatted documentation with detail information.

### **PS A7 PAYMENT CERTIFICATE**

The interim claim for payment to the contractor will be set out on a typed form similar to the Schedule of Quantities. A preliminary copy will be submitted to the engineer for approval where after it will be returned, with or without changes, to the contractor for submission of the final payment claim.

### **PS A8 ERECTION OF CAMP, DELIVERY OF EQUIPMENT TO THE SITE AND ACCOMMODATION AND OFFICES FOR SUPERVISING PERSONNEL**

#### **PS A8.1 Description:**

This part of the work entails the erection and maintenance of the construction camp (depot) required for the execution of the works. It includes all offices, storage facilities, workshop sheds, sanitary facilities, water and electricity supply and the maintenance facilities required according to the conditions of contract and the specifications for the successful completion of the work. It includes accommodation of workers. It also includes the transport of personnel, equipment and other items to and from the site, the restoration of all semi-permanent buildings and the removal of all temporary buildings and equipment after completion of the works.

#### **PS A8.2 Accommodation:**

The contractor must make his own arrangements for accommodation.

#### **PS A8.3 Site of construction camp (depot)**

The general location of the camp sites need to be adjacent or as close as possible to the buildings to as to ensure minimum impact to the environment. The more specific location of the sites will be finalised on site in consultation with the Employer and Engineer.

The contractor is responsible for all earthworks, drainage, fencing and access, and maintenance and security of the construction camps for the period of the contract.

#### **PS A8.4 Semi-permanent buildings:**

All buildings used by the contractor as offices, storage facilities; workshops, laboratories, sheds and sanitary facilities must be of a temporary nature. The size of the buildings must be determined by the contractor. Sufficient facilities only for the purpose of this contract must be supplied.

Adequate sanitary facilities must be supplied by the contractor, erected according to the local authority's specifications on approved spots to the satisfaction of the engineer.

## **PS A9 FINISHING OFF AND CLEARING UP OF SITE**

### **PS A9.1 Description:**

After completion of the works the contractor is responsible for the finishing off and clearing up of the site. This work entails the clearing of all obvious signs of construction activities like building equipment, excess material, debris and temporary works to the satisfaction of the engineer.

### **PS A9.2 Access roads on the site:**

Access roads on the site, as well as embankments and excavations must be smoothed and shaped to even planes to the satisfaction of the engineer. All changes in gradient must be properly shaped.

## **PS A10 DEFECTS LIABILITY**

The defects liability period shall not be applicable for this work.

## **PS A11 PAYMENT FOR ITEMS UNDER GENERAL**

### **PS A11.1 Site establishment:**

Payment for site establishment will be done once it is complete and complying with safety requirements.

### **PS A11.2 Clearing and finishing off:**

Payment for this item will be made when clearing and finishing off has been completed.

### **PS A11.3 Time related obligations:**

Time related obligations will not be subject to escalation and payment will be made in equal amounts during the construction period.

## **PS A12 RECEIPT AND STORAGE OF MATERIAL**

The contractor is responsible for the receipt of material on site, as well as the safe storage thereof. He is responsible for the control of deliveries and signing of delivery notes. The contractor will ensure that all material delivered be in good condition and will return defective material immediately. The contractor must ensure that no damage is done during handling of material on site and is fully responsible for any damages before or during installation.

## **PS C CLEARING (SABS 1200 C)**

### **PS C1 CONSERVATION OF FAUNA AND FLORA**

It is required that the contractor will only clear the minimum width for construction work and related activities.

### **PS C2 REMOVAL OF TOPSOIL**

The removal and stockpiling of topsoil will be indicated on site. The levelling of topsoil is required.

### **PS C3 DISPOSAL OF MATERIAL**

Disposal areas are not available on site. The Contractor shall locate his own disposal areas and shall remove and cart away any accumulation of material generated by his construction activities and not required for further use in the Works. The cost of loading, carting away and disposing of material shall be deemed to have been included in the excavation rates.

Care should be taken during clearing that no significant amounts of topsoil are being removed and pushed into windrows. Should that be found, contractor will move such topsoil back at his own cost.

### **C3.3 PARTICULAR SPECIFICATIONS**

- PART C: STANDARD SPECIFICATIONS FOR BUILDING TRADES**
- PART D: ENVIRONMENTAL MANAGEMENT**
- PART E: OHSA 1993 SAFETY SPECIFICATION**

## RIVER ABSTRACTION PUMP STATION WITH WATER TREATMENT PLANT FOR INKANYEZI POULTRY FARM IN CALM, GERT SIBANDE DISTRICT

### **C3.3 PARTICULAR SPECIFICATIONS**

In addition to the Standardised and Project Specifications the following Particular Specifications shall apply to this contract and are bound in hereafter.

**PART D: ENVIRONMENTAL MANAGEMENT**

**PART E: OHSA 1993 SAFETY SPECIFICATION**

## **PART D: ENVIRONMENTAL MANAGEMENT SPECIFICATION**

### **D1 General**

In order to ensure that the construction works is carried out in an environmentally sensitive matter, strict compliance to the Environmental Management Plan (EMP) guidelines is required. The purpose of the EMP is to:

- Encourage good management practices through planning and commitment to environmental issues,
- Provide rational and practical environmental guidelines to:
  - a) Minimise disturbance of the natural environment,
  - b) Prevent pollution of land, air and water,
  - c) Prevent soil erosion and facilitate re-vegetation.
- Adopt the best practicable means available to prevent or minimise adverse environmental impact,
- Develop waste management practices based on prevention, minimisation, recycling, treatment or disposal of wastes,
- Train employees and contractors with regard to environmental obligations.

### **D2 Training and Induction of Employees**

The Contractor has a responsibility to ensure that all those people involved in the project are aware of and familiar with the environmental requirements for the project (this includes sub-contractors, casual labour, etc.). The EMP shall be part of the terms of reference for all contractors, sub-contractors and suppliers.

### **D3 Complaints Register and Environmental Incident Book**

Any complaints received by the project team from the public will be recorded. The complaint should be brought to the attention of the site manager, who will respond.

The following information must be recorded:

- Time, date and nature of the complaint,
- Type of communication (telephone, letter etc),
- Name, contact address and telephone number of the complainant,
- Response and investigation undertaken and
- Actions taken and by whom.

All complaints received will be investigated and a response given to the complainant within 14 days.

All environmental incidents occurring on the site will be recorded. The following information will be provided:

- Time, date, location and nature of the incident,
- Actions taken and by whom.

### **D4 Site Cleanliness and Neatness**

- Location of a construction camp is to be approved by the Engineer and is to be restored to its previous condition after completion of construction.
- The construction camp should preferably be fenced with a 1.8m bonnox fence or similar approved.
- All materials, equipment, plant and vehicles must be stored within the construction camp.
- A dedicated area must be made available for construction staff to change and store their personal belongings.

### **D5 Access**

- Access to existing roads, schools, buildings, shop and residential properties must not be impeded during construction.
- Access roads utilised by the Contractor must be maintained in good condition.

---

**D6 Borrow Pits**

- Mining authorisations (permits) for borrow pits must be obtained from the Department of Minerals and Energy (DME) in consultation with the Department of Water Affairs (DWA).
- Spoil dumps resulting from borrow pits must not interfere with any natural surface drainage.
- Borrow pits must be rehabilitated after use in accordance with the requirements of DME and DWA.
- Official consultation and approval must be followed before utilizing existing burrow pits.

**D7 Dust Control / Air Quality**

- Dust suppression measures must be implemented during construction by ensuring that all surfaces prone to dust generation are kept damp (e.g. use of water tanker).
- Ensure that vehicles and equipment are in good working conditions and that emissions are not excessive.
- Ensure that vehicles and equipment are in good working conditions and that emissions are not excessive.
- Special care must be taken in areas where the route passes close to schools and residential areas.
- The speed of construction vehicles must be reduced.

**D8 Fauna**

Contractor staff may not chase, catch or kill animals encountered during construction.

**D9 Fire Prevention and Control**

- Smoking is prohibited in the vicinity of flammable substances.
- The contractor must ensure that fire-fighting equipment is available on site, particularly where flammable substances are being stored or used, and that construction staff are aware of where it is kept and how it is operated.
- Fires started for comfort (warmth) are prohibited, due to the risk of veld fires and risk to adjacent property owner's lands.

**D10 Grave sites**

Gravesites in close proximity to the road must not be disturbed during construction.

**D11 Materials Handling and Spills Management**

- Any hazardous materials to be used during construction (e.g. lime, fuel, paint, etc) are to be stored in a designated area at the campsite.
- The storage containers/facilities (including any diesel/petrol tanks) must be placed on an impermeable surface and surrounded by a bund wall, in order to ensure that accidental spillage does not pollute the environment.
- Workers must at all times be made aware of the health and safety risks associated with any hazardous substances used (e.g. smoking near fuel tanks), and must be provided with appropriate protective clothing/equipment in case of spillages or accidents.
- Ensure all staff and contractors undergo relevant training in the maintenance of equipment to prevent the accidental discharge or spill of fuel, oil, lubricants and other chemicals.
- Any spill of potentially hazardous materials must be cleaned up immediately (Potentially hazardous materials on site include paint, oil, grease, fuel, turpentine, etc).
- The area of contaminated soil or spill must be deposited into the hazardous waste container(s).
- The contractor should keep Peat Sorb or a similar absorbent on site to clean up any spills.
- The absorbent must be stored in a designated area and be available for inspection.
- All spills are to be recorded in the environmental incident book.

**D12 Noise**

- Noise generating activities must be restricted to between 07h00 and 17h00 Monday to Friday, unless otherwise approved by the appropriate competent person in consultation with adjacent landowners/affected persons.

- All equipment, vehicles and machinery must be in good working conditions and be equipped with sound mufflers if necessary.
- Construction staff must be trained and made aware of not creating unnecessary noise such as hooting and shouting.

**D13            Pollution Control**

- Soil and water pollution through usage of fuel, oil, paint, bitumen or other hazardous substances must be avoided.
- All construction vehicles are to be maintained in good working order so as to prevent soil or water pollution from oil, fuel or other leaks, and to reduce noise pollution.

**D14            Rivers and Streams**

- During construction of bridge structures, there must be no obstruction of the water flow of rivers and streams.
- Excavated material must not be stockpiled on or near riverbanks, in order to prevent sedimentation occurring.
- Erosion control measures must be employed both during and after construction.
- No impediments to natural surface water flow, other than approved erosion control measures, must occur.

**D15            Safety**

- Safety measures, such as detour signs, must be implemented during construction to ensure the safety of workers, pedestrians and drivers/passengers in vehicles in the vicinity of construction work.
- Special care must be taken in the vicinity of schools to ensure the safety of children wishing to cross the road under construction.
- The relevant signage (e.g. speed control signs) must be erected alongside the road during the operation phase in order to control traffic.
- Accommodation must be made for pedestrian pathways alongside the road during the construction and operation phases.

**D16            Soil Management**

- Storm water drainage pipes must be installed alongside the road in all areas susceptible to soil erosion.
- Erosion should be minimised by the construction of meadow drains and the planting of indigenous vegetation on the side slopes and drains to reduce flow velocity of stormwater.
- Spoil from cuts may be used in existing erosion galleys.
- Stone pitching and gabions should be constructed at pipe culvert outlets.
- Accidental spills of contaminants onto the ground e.g. oil, concrete, fuel and chemicals should be removed together with the contaminated soil.
- If necessary an absorbent such as Peat Sorb should be used the aid in cleaning up the spill. The contaminated soil should be disposed of in an appropriate container, depending on its classification.
- Servicing and re-fuelling of vehicles must only be carried out at construction camp.

**D17            Worker Conduct**

Code of Conduct for Construction Personnel:

- Do not leave the construction site untidy and strewn with rubbish which will attract animal pests.
- Do not set fires.
- Do not cause any unnecessary, disturbing noise at the construction camp/site or at any designated worker collection/drop off points.
- Do not drive a construction-related vehicle under the influence of alcohol.
- Do not exceed the national speed limits on public roads or exceed the recommended speed limits on the site.
- Do not drive a vehicle which is generating excessive noise or gaseous pollution (noisy vehicles must be reported and repaired as soon as possible).
- Do not litter along the roadsides, including both the public and private roads.
- Do not pollute any water bodies (whether flowing or not).
- No member of the construction team is allowed to enter the areas outside the construction site.

#### **D18 Traffic Disturbances and Diversions**

- Any traffic diversions must be undertaken with the approval of all relevant authorities and in accordance with all relevant legislation.
- Wherever possible, traffic diversion must only take place on existing disturbed areas and remain within the existing road reserve.
- Traffic diversion routes must be rehabilitated after use.

#### **D19 Vegetation**

- Only vegetation falling directly on the route must be removed where necessary.
- Alien vegetation within the road reserve must be eradicated, and management measures must be implemented for future control of these species.
- Vegetation that has been removed from large areas (e.g. on traffic diversion routes) during construction must be replaced with indigenous vegetation after construction has been completed.

#### **D20 Waste Management**

- All general, non-hazardous waste must be placed in a skip container and disposed of at a registered waste disposal site.
- The container is to ensure that the portable toilet facilities at the campsite are properly maintained and in working order.
- No disposal, or leakage, of sewage must occur on or near the site.
- All hazardous waste (e.g. oil, plant empty lime bags, contaminated wash water, etc) must be stored in leakproof containers and disposed of a registered hazardous waste disposal site.
- The contents of waste storage containers must, under no circumstances, be emptied to the surrounding area. In general, littering, discarding or burying of any materials is not allowed on site or along the route.
- Adequate waste receptacles must be available at strategic points around the construction camp and site for all domestic refuse and to minimise the occurrence of littering.
- Concrete rubble must be collected and disposed of as directed by the Project Manager.
- Each working area must be cleared of litter and building waste (e.g. rubble, wood, concrete packets etc) on completion of the day's work.

**Any spill around the container(s) should be treated as per Section D11 and D16.**

## **PART E: OHSA 1993 HEALTH AND SAFETY SPECIFICATION**

### **E1 SCOPE**

This specification covers the health and safety requirements to be met by the Contractor to ensure a continued safe and healthy environment for all workers, employees and subcontractors under his control and for all other persons entering the site of works.

This specification shall be read with the Occupational Health and Safety Act (Act No 85 and amendment Act No 181) 1993, and the corresponding Construction Regulations 2003, and all other safety codes and specifications referred to in the said Construction Regulations.

In terms of the OHS Agreement in Section C1.2.4 of the Contract document, the status of the Contractor as mandatory to the Employer (client) is that of an employer in his own right, responsible to comply with all provisions of OHS 1993 and the Construction Regulations 2003.

This safety specification and the Contractor's own Safety Plan as well as the Construction Regulations 2003, shall be displayed on site or made available for inspection by all workers, employees, inspectors and any other persons entering the site of works.

The following are possible risks associated with this project:

- Working high above ground on top and in a restricted environment with limited landings (working platforms)
- Working in a flood plain environment subject to flooding
- Lifting and lowering of materials and equipment from the ground and vice versa, exposed to cross winds
- Steep and restricted access
- Potentially dangerous existing services, i.e. gas lines, water and sewerage mains, electrical high voltage cables, on the bridge, buried and overhead
- Deep excavations in soils requiring shoring or reducing of slopes
- Blasting of hard rock or demolition of concrete
- High pressure during testing of the relocated pipe lines, which could result in potentially dangerous situations in the event of the pipeline or fittings failing
- Potentially harmful gasses when tying into the existing sewer mains
- Movement of construction vehicles on site, taking into consideration steep slopes, other traffic and existing services
- Exposure to possible injuries due to mishandling or failure of power and hand tools
- Falling debris, tools and materials from bridge
- Non-conformance to specifications with regards to fasteners and materials
- Risks related to general safety and security on site

Additional risks may arise from specific methods of construction selected by the Contractor which are not necessary covered in the above.

### **E2 DEFINITIONS**

For the purpose of this contract the following shall apply:

- a) **Employer** where used in the contract documents and in this specification, means the Employer as defined in the General Conditions of Contract and it shall have the exact same meaning as **client** as defined in the Construction Regulations 2003. **Employer** and **client** is therefore interchangeable and shall be read in the context of the relevant document.
- b) **Contractor** wherever used in the contract documents and in this specification, shall have the same meaning as **Contractor** as defined in the General Conditions of Contract.

In this specification the terms **principal contractor** and **contractor** are replaced with **Contractor** and **subcontractor** respectively.

---

For the purpose of this contract the **Contractor** will, in terms of OHSA 1993, be the mandatory, without derogating from his status as an employer in his own right.

- c) "**Engineer**" where used in this specification, means the Engineer as defined in the General Conditions of Contract. In terms of the Construction Regulations the Engineer may act as agent on behalf of the Employer (the client as defined in the Construction Regulations).

### **E3 BIDS**

The Contractor shall submit the following with his Bid:

- a) a documented Health and Safety Plan as stipulated in Regulation 5 of the Construction Regulations. The Safety Plan must be based on the Construction Regulations 2003 and will be subject to approval by the Employer;
- b) a declaration to the effect that he has the competence and necessary resources to carry out the work safely in compliance with the Construction Regulations 2003;
- c) a declaration to the effect that he made provision in his Bid for the cost of the health and safety measures envisaged in the Construction Regulations;
- d) Failure to submit the foregoing with his Bid, will lead to the conclusion that the Contractor will not be able to carry out the work under the contract safely in accordance with the Construction Regulations.

### **E4 NOTIFICATION OF COMMENCEMENT OF CONSTRUCTION WORK**

After award of the contract, but before commencement of construction work, the Contractor shall, in terms of Regulation 3, notify the Provincial Director of the Department of Labour in writing if the following work is involved:

- a) the demolition of structures and dismantling of fixed plant of height of 3,0m or more;
- b) the use of explosives;
- c) construction work that will exceed 30 days or 300 person-days;
- d) excavation work deeper than 1,0m; or
- e) working at a height greater than 3,0m above ground or landings.

The notification must be done in the form of the pro forma included under Section 9 (Forms to be completed by Successful Service Provider) of the Bid document.

A copy of the notification form must be kept on site, available for inspection by inspectors, Employer, Engineer, employees and persons on site.

### **E5 RISK ASSESSMENT**

Before commencement of any construction work during the construction period, the Contractor shall have a risk assessment performed and recorded in writing by a competent person. (Refer Regulation 7 of the Construction Regulations 2003).

The risk assessment shall identify and evaluate the risks and hazards that may be expected during the execution of the work under the contract, and it shall include a documented plan of safe work procedures to mitigate, reduce or control the risks and hazards identified.

The risk assessment shall be available on site for inspection by inspectors, Employer, Engineer, subcontractors, employees, trade unions and health and safety committee members, and must be monitored and reviewed periodically by the Contractor.

## **APPOINTMENT OF EMPLOYEES AND SUBCONTRACTORS**

### **E5.1 Health and Safety plan**

The Contractor shall appoint his employees and any subcontractors to be employed on the contract, in writing, and he shall provide them with a copy of his documented Health and Safety Plan, or relevant sections thereof. The Contractor shall ensure that all subcontractors and employees are committed to the implementation of his Safety Plan.

### **E5.2 Health and safety induction training**

The Contractor shall ensure that all employees under his control, including subcontractors and their employees, undergo a health and safety induction training course by a competent person before commencement of construction work. No visitor or other person shall be allowed or permitted to enter the site of the works unless such person has undergone health and safety training pertaining to hazards prevalent on site.

The Contractor shall ensure that every employee on site shall at all times be in possession of proof of the health and safety induction training issued by a competent person prior to commencement of construction work.

## **E6 APPOINTMENT OF SAFETY PERSONNEL**

### **E6.1 Construction Supervisor**

The Contractor shall appoint a full-time **Construction Supervisor** with the duty of supervising the performance of the construction work.

He may also have to appoint one or more competent employees to assist the construction supervisor where justified by the scope and complexity of the works.

### **E6.2 Construction safety officer**

Taking into consideration the size of the project and the hazards or dangers that can be expected, the Contractor shall appoint in writing a full-time or part-time **Construction Safety Officer** if so decided by the Inspector of the Department of Labour. The Safety Officer shall have the necessary competence and resources to perform his duties diligently.

Provision shall be made by the Contractor in his rates, to cover the cost of this dedicated construction safety officer appointed after award of the contract.

### **E6.3 Health and safety representatives**

In terms of **Section 17 and 18 of the Act (OHSA 1993)** the Contractor, being the employer in terms of the Act for the execution of the contract, shall appoint a **health and safety representative** whenever he has more than 20 employees in his employment on the site of the works. The health and safety representative must be selected from employees who are employed in a full-time capacity at a specific workplace.

The number of health and safety representatives for a workplace shall be at least one for every 100 employees.

The function of health and safety representative(s) will be to review the effectiveness of health and safety measures, to identify potential hazards and major incidents, to examine causes of incidents (in collaboration with his employer, the Contractor), to investigate complaints by employees relating to health and safety at work, to make representations to the employer (Contractor) or inspector on general matters affecting the health and safety of employees, to inspect the workplace, plant, machinery etc. on a regular base, to participate in consultations with inspectors and to attend meetings of the health and safety committee.

### **E6.4 Health and safety committee**

In terms of **Sections 17 and 18 of the Act (OHSA 1993)** the Contractor (as employer), shall establish one or more **health and safety committee(s)** where there are two or more health and safety representatives at a workplace.

---

The persons selected by the Contractor to serve on the committee shall be designated in writing.

The function of the health and safety committee shall be to hold meetings at regular intervals, but at least once every three months, to review the health and safety measures on the contract, to discuss incidents related to health and safety with the Contractor and the inspector, and to make recommendations regarding health and safety to the Contractor and to keep record of recommendations and reports made by the committee.

### **E6.5 Competent persons**

In accordance with the Construction Regulations the Contractor has to appoint in writing **competent persons** responsible for supervising construction work on each of the following work situations that may be expected on the site of the works.

- a) Risk assessment and induction training as described in Regulation 7 of the Construction Regulations;
- b) Fall protection as described in Regulation 8;
- c) Formwork and support work as described in Regulation 10;
- d) Excavation work as described in Regulation 11;
- e) Demolition work as described in Regulation 12;
- f) Scaffolding work as described in Regulation 14;
- g) Suspended platform operations as described in Regulation 15;
- h) Material hoists as described in Regulation 17;
- i) Batch plant operations as described in Regulation 18;
- j) Explosive powered tools as described in Regulation 19;
- k) Cranes as described in Regulation 20;
- l) Construction vehicle and mobile plant inspections on a daily basis by a competent person as described in Regulation 21(1);
- m) Control of all temporary electrical installation on the construction site as described in Regulation 22;
- n) Stacking and storage on construction sites as described in Regulation 26; and
- o) Inspections of fire equipment as described in Regulation 27.

A competent person may be appointed for more than one part of the construction work with the understanding that the person must be suitably qualified and able to supervise at the same time the construction work on all the work situations for which he has been appointed.

The appointment of competent persons to supervise parts of the construction work does not relieve the Contractor from any of his responsibilities to comply with **all** requirements of the Construction Regulations.

## **E7 RECORDS AND REGISTERS**

In accordance with the Construction Regulations the Contractor is bound to keep records and registers related to health and safety on site for periodic inspection by inspectors, the Engineer, the Employer, trade union officials and subcontractors and employees. The following records and registers must be kept on site and shall be available for inspection at all times.

- a) A copy of the OHS Act 1993 Construction Regulations 2003;
- b) A copy of this Health and Safety Specification;
- c) A copy of the Contractor's Health and Safety Plan (Regulation 4);
- d) A copy of the Notification of Construction Work (Regulation 3);
- e) A health and safety file in terms of Regulation 5(7) with inputs by the Construction Safety Officer (Regulation 6(7));
- f) A copy of the risk assessment described in Regulation 7;
- g) A full protection plan and the corresponding records of evaluation and training of employees working from elevated positions as described in Regulation 8;
- h) Drawings pertaining to the design of structures (Regulation 9(3)) and formwork and support work structures (Regulation 10(d)) must be kept on site;
- i) Pronouncement of the safety of excavations must be recorded in a register to be kept on site (Regulation 11(3)(h));
- j) A copy of the certificate of the system design for suspended platforms (Regulation 15(3));
- k) A notice must be affixed around the base towers of material hoists to indicate the maximum mass load, which may be carried at any one time by material hoists (Regulation 7(5));
- l) Maintenance records of material hoists and inspection results must be kept in a record book to be kept on site (Regulation 17(8));

- m) A record of any repairs to or maintenance of a batch plant must be kept on site (Regulations 18(9));
- n) A warning notice must be displayed in a conspicuous manner when and wherever an explosive powered tool is used (Regulation 19(2));
- o) A register for recording of findings by the competent person appointed to inspect construction vehicles and mobile plant (Regulation 21(1)(j)).

## **E8 CONTRACTORS RESPONSIBILITIES**

For this contract the Contractor will be the mandatory of the Employer (Client), as defined in the Act (OHSA 1993), which means that the Contractor has the status of employer in his own right in respect of the contract. The Contractor is therefore responsible for all the duties and obligations of an employer as set out in the Act (OHSA 1993) and the Construction Regulations 2003.

Before commencement of work under the contract, the Contractor shall enter into an agreement with the Employer (Client) to confirm his status as mandatory (employer) for the contract under consideration.

The Contractor's duties and responsibilities are clearly set out in the Construction Regulations 2003, and are not repeated in detail but some important aspects are highlighted hereafter, without relieving the Contractor of any of his duties and responsibilities in terms of the Construction Regulations.

### a) Contractor's position in relation to the Employer (Client) (Regulation 4)

In accordance with Section 4 of the Regulations, the Contractor shall liaise closely with the Employer or the Engineer on behalf of the Employer, to ensure that all requirements of the Act and the Regulations are met and complied with.

### b) The Principal Contractor and Contractor (Regulation 5)

The Contractor is in terms of the definition in Regulation 2(b) the equivalent of Principle Contractor as defined in the Construction Regulations, and he shall comply with all the provisions of Regulation 5.

Any subcontractors employed by the Contractor must be appointed in writing, setting out the terms of the appointment in respect of health and safety. An independent subcontractor shall however provide and demonstrate to the Contractor a suitable, acceptable and sufficiently documented health and safety plan before commencement of the subcontract. In the absence of such a health and safety plan the subcontractor shall undertake in writing that he will comply with the Contractor's safety plan, the health and safety specifications of the Employer and the Construction Regulations 2003.

### c) Supervision of construction work (Regulation 6)

The Contractor shall appoint the safety and other personnel and employees as required in terms of Regulation 6 and as set out in paragraph 7 above. Appointment of those personnel and employees does not relieve the Contractor from any of the obligations under Regulation 6.

### d) Risk assessment (Regulation 7)

The Contractor shall have the risk assessment made as set out in paragraph 7 above before commencement of the work and it must be available on site for inspection at all times. The Contractor shall consult with the health and safety committee or health and safety representative(s) etc. on a regular basis to ensure that all employees, including subcontractors under his control, are informed and trained by a competent person regarding health hazards and related work procedures.

No subcontractor, employee or visitor shall be allowed to enter the site of works without prior health and safety induction training, all as specified in Regulation 7.

### e) Fall protection (Regulation 8)

Fall protection, if applicable to this contract shall comply in all respects with Regulation 8 of the Construction Regulations.

### f) Structures (Regulation 9)

---

The Contractor will be liable for all claims arising from collapse or failure of structures if he failed to comply with all the specifications, project specifications and drawings related to the structures, unless it can be proved that such collapse or failure can be attributed to faulty design or insufficient design standards on which the specifications and the drawings are based.

In addition the Contractor shall comply with all aspects of Regulation 9 of the Construction Regulations.

g) Formwork and support work (Regulation 10)

The Contractor will be responsible for the adequate design of all formwork and support structures by a competent person.

All drawings pertaining to formwork shall be kept on site and all equipment and materials used in formwork, shall be carefully examined and checked for suitability by a competent person.

The provisions of Regulation 10 of the Construction Regulations shall be followed in every detail.

h) Excavation work (Regulation 11)

It is essential that the Contractor shall follow the instructions and precautions in the Standard Specifications and Project Specifications as well as the provisions of the Construction Regulations to the letter as unsafe excavations can be a major hazard on any construction site. The Contractor shall therefore ensure that all excavation work is carried out under the supervision of a competent person, that inspections are carried out by a Professional Engineer or Technologist, and that all work is done in such a manner that no hazards are created by unsafe excavations and working conditions.

Supervision by a competent person will not relieve the Contractor from any of his duties and responsibilities under Regulation 11 of the Construction Regulations.

i) Demolition work (Regulation 12)

Whenever demolition work is included in a contract, the Contractor shall comply with all the requirements of Regulation 12 of the Construction Regulations. The fact that a competent person has to be appointed by the Contractor does not relieve the Contractor from any of his responsibilities in respect of safety of demolition work.

j) Tunnelling (Regulation 13)

The Contractor shall comply with Regulation 13 wherever tunnelling of any kind is involved.

k) Scaffolding (Regulation 14)

The Contractor shall ensure that all the provisions of Regulation 14 of the Construction Regulations are complied with. [Note: Reference in the Regulations to "Section 44 of the Act" should read "Section 43 of the Act"].

l) Suspended platforms (Regulation 15)

Wherever suspended platforms will be necessary on any contract, the Contractor shall ensure that copies of the system design issued by a Professional Engineer are submitted to the Engineer for inspection and approval. The Contractor shall appoint competent persons as supervisors and competent scaffold erectors, operators and inspectors and ensure that all work related to suspended platforms are done in accordance with Regulation 15 of the Construction Regulations.

m) Boatswain's chains (Regulation 16)

Where boatswain's chains are required on the construction site, the Contractor shall comply with Regulation 16.

n) Material Hoists (Regulation 17)

Wherever applicable, the Contractor shall comply with the provisions of Regulation 17 to the letter.

o) Batch plants (Regulation 18)

Wherever applicable, the Contractor shall ensure that all lifting machines, lifting tackle, conveyors, etc. used in the operation of a batch plant shall comply with, and that all operators, supervisors and employees are strictly held to the provisions of Regulation 18. The Contractor shall ensure that the General Safety Regulations (Government Notice R1031 of 30 May 1986), the Driven Machinery Regulations (Government Notice R295 of 26/2/1988) and the Electrical Installation Regulations (Government Notice R2271 of 11/10/1995) are adhered to by all involved.

In terms of the Regulations, records of repairs and maintenance shall be kept on site.

p) Explosive powered tools (Regulation 19)

The Contractor shall ensure that, wherever explosive-powered tools are required to be used, all safety provisions of Regulation 19 are complied with.

It is especially important that warning notices are displayed and that the issue and return of cartridges and spent cartridges be recorded in a register to be kept on site.

q) Cranes (Regulation 20)

Wherever the use of tower cranes becomes necessary, the provisions of Regulation 20 shall be complied with.

r) Construction vehicles And mobile plant (Regulation 21)

The Contractor shall ensure that all construction vehicles and plant are in good working condition and safe for use, and that they are used in accordance with their design and intended use. The vehicles and plant shall only be operated by workers or operators who have received appropriate training, all in accordance with all the requirements of Regulation 21.

All vehicles and plant must be inspected on a daily basis, prior to use, by a competent person and the findings must be recorded in a register to be kept on site.

s) Electrical installation and machinery on construction sites (Regulation 22)

The Contractor shall comply with the Electrical Installation Regulations (Government Notice R2920 of 23 October 1992) and the Electrical Machinery Regulations (Government Notice R1953 of 12 August 1993). Before commencement of construction, the Contractor shall take adequate steps to ascertain the presence of, and guard against dangers and hazards due to electrical cables and apparatus under, over or on the site.

All temporary electrical installations on the site shall be under the control of a competent person, without relieving the Contractor of his responsibility for the health and safety of all workers and persons on site in terms of Regulation 22.

t) Use of temporary storage of flammable liquids on construction sites (Regulation 23)

The Contractor shall comply with the provisions of the General Safety Regulations (Government Notice R1031 of 30 May 1986) and all the provisions of Regulation 23 of the Construction Regulations to ensure a safe and hazard-free environment to all workers and other persons on site.

u) Water environments (Regulation 24)

Where construction work is done over or in close proximity to water, the provisions of Regulation 24 shall apply.

v) Housekeeping on Construction sites (Regulation 25)

Housekeeping on all construction sites shall be in accordance with the provisions of the environment Regulations for workplaces (Government Notice R2281 of 16 October 1987) and all the provisions of Regulation 25 of the Construction Regulations.

w) Stacking and storage on construction sites (Regulation 26)

The provisions for the stacking of articles contained in the General Safety Regulations (Government Notice R1031 of 30 May 1986) as well as all the provisions Regulation 26 of the Construction Regulations shall apply.

x) Fire precautions on construction sites (Regulation 27)

The provisions of the Environmental Regulations for Workplaces (Government Notice R2281 of 16 October 1987) shall apply.

In addition, the necessary precautions shall be taken to prevent the incidence of fires, to provide adequate and sufficient fire protection equipment, sirens, escape routes etc. all in accordance with Regulation 27 of the Construction Regulations.

y) Construction welfare facilities (Regulation 28)

The Contractor shall comply with the construction site provisions as in the Facilities Regulations (Government Notice R1593 of 12 August 1988) and the provisions of Regulation 28 of the Construction Regulations.

z) Non-compliance with the Construction Regulations 2003

The foregoing is a summary of parts of the Construction Regulations applicable to all construction projects.

The Contractor, as employer for the execution of the contract, shall ensure that all provisions of the Construction Regulations applicable to the contract under consideration are complied with to the letter.

Should the Contractor fail to comply with the provisions of the Regulations 3 to 28 as listed in Regulation 30, he will be guilty of an offence and will be liable, upon conviction, to the fines or imprisonment as set out in Regulation 30.

***The Contractor is advised in his own interest to make a careful study of the Act and the Construction Regulations as ignorance of the Act and the Regulations will not be accepted in any proceedings related to non-conformance to the Act and the Regulations.***

## **E9 MEASUREMENT AND PAYMENT**

### **F9.1 Principles**

It is a condition of this contract that Contractors, who submit Bids for this contract, shall make provision in their Bids for the cost of all health and safety measures during the construction process. All associated activities and expenditure are deemed to be included in the Contractor's Bided rates and prices.

a) Safety personnel

The Construction Supervisor, the Construction Safety Officer, Health and Safety Representatives, Health and Safety Committee and Competent Persons referred to in clauses 7.1 to 7.5 shall be members of the Contractor's personnel, and no additional payment will be made for the appointment of such safety personnel.

b) Records and Registers

The keeping of health and safety-related records and registers as described in 8 is regarded as a normal duty of the Contractor for which no additional payment will be considered, and which is deemed to be included in the Contractor's Bided rates and prices.

## **PART C 4: SITE INFORMATION**

### **C4.1: LOCALITY PLAN**

### **C4.2: CONSTRUCTION NOTICE BOARD**

#### **C4.1 LOCALITY PLAN**

***The Locality of the Site can be obtained from the coordinates given in the scope of works.***

## **C4.2 CONSTRUCTION NOTICE BOARD**

***See Details on attached Drawings***







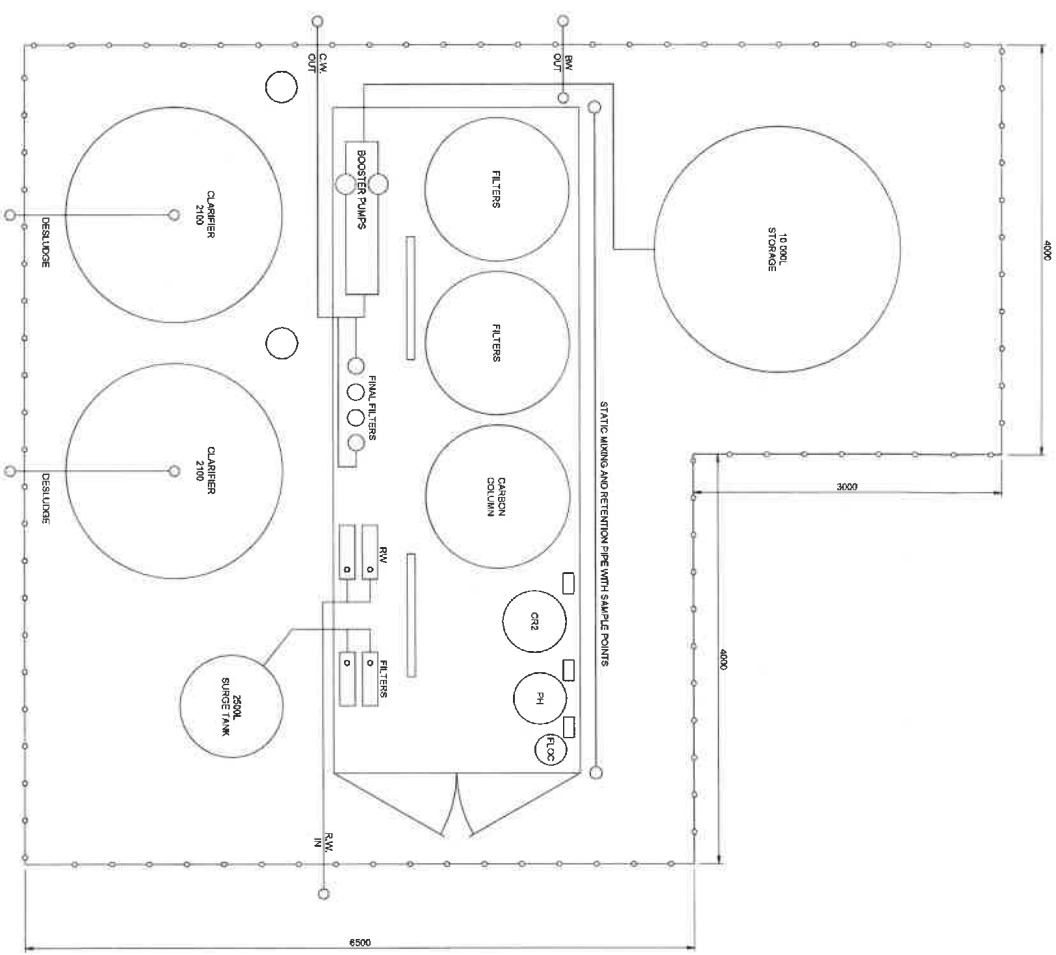

|    |      |    |    |    |
|----|------|----|----|----|
| 1  | DATE | 1  | 1  | 1  |
| 2  | DATE | 2  | 2  | 2  |
| 3  | DATE | 3  | 3  | 3  |
| 4  | DATE | 4  | 4  | 4  |
| 5  | DATE | 5  | 5  | 5  |
| 6  | DATE | 6  | 6  | 6  |
| 7  | DATE | 7  | 7  | 7  |
| 8  | DATE | 8  | 8  | 8  |
| 9  | DATE | 9  | 9  | 9  |
| 10 | DATE | 10 | 10 | 10 |
| 11 | DATE | 11 | 11 | 11 |
| 12 | DATE | 12 | 12 | 12 |
| 13 | DATE | 13 | 13 | 13 |
| 14 | DATE | 14 | 14 | 14 |
| 15 | DATE | 15 | 15 | 15 |
| 16 | DATE | 16 | 16 | 16 |
| 17 | DATE | 17 | 17 | 17 |
| 18 | DATE | 18 | 18 | 18 |
| 19 | DATE | 19 | 19 | 19 |
| 20 | DATE | 20 | 20 | 20 |
| 21 | DATE | 21 | 21 | 21 |
| 22 | DATE | 22 | 22 | 22 |
| 23 | DATE | 23 | 23 | 23 |
| 24 | DATE | 24 | 24 | 24 |
| 25 | DATE | 25 | 25 | 25 |
| 26 | DATE | 26 | 26 | 26 |
| 27 | DATE | 27 | 27 | 27 |
| 28 | DATE | 28 | 28 | 28 |
| 29 | DATE | 29 | 29 | 29 |
| 30 | DATE | 30 | 30 | 30 |

CLIENT: MANUKALIA WASTEWATER LAND & ENVIRONMENTAL SERVICES  
 10000 L STORAGE  
 FILTERS  
 CARBON COLUMN  
 BOOSTER PUMPS  
 FINAL FILTERS  
 200L SURGE TANK  
 CLARIFIER 2100  
 CLARIFIER 2100  
 DESLUDGE  
 DESLUDGE  
 RW IN  
 RW OUT  
 CW OUT  
 STATS WIRING AND RESTRICTION PIPE WITH SAMPLE POINTS

CLIENT: MANUKALIA WASTEWATER LAND & ENVIRONMENTAL SERVICES  
 10000 L STORAGE  
 FILTERS  
 CARBON COLUMN  
 BOOSTER PUMPS  
 FINAL FILTERS  
 200L SURGE TANK  
 CLARIFIER 2100  
 CLARIFIER 2100  
 DESLUDGE  
 DESLUDGE  
 RW IN  
 RW OUT  
 CW OUT  
 STATS WIRING AND RESTRICTION PIPE WITH SAMPLE POINTS

CLIENT: MANUKALIA WASTEWATER LAND & ENVIRONMENTAL SERVICES  
 10000 L STORAGE  
 FILTERS  
 CARBON COLUMN  
 BOOSTER PUMPS  
 FINAL FILTERS  
 200L SURGE TANK  
 CLARIFIER 2100  
 CLARIFIER 2100  
 DESLUDGE  
 DESLUDGE  
 RW IN  
 RW OUT  
 CW OUT  
 STATS WIRING AND RESTRICTION PIPE WITH SAMPLE POINTS

CLIENT: MANUKALIA WASTEWATER LAND & ENVIRONMENTAL SERVICES  
 10000 L STORAGE  
 FILTERS  
 CARBON COLUMN  
 BOOSTER PUMPS  
 FINAL FILTERS  
 200L SURGE TANK  
 CLARIFIER 2100  
 CLARIFIER 2100  
 DESLUDGE  
 DESLUDGE  
 RW IN  
 RW OUT  
 CW OUT  
 STATS WIRING AND RESTRICTION PIPE WITH SAMPLE POINTS

CLIENT: MANUKALIA WASTEWATER LAND & ENVIRONMENTAL SERVICES  
 10000 L STORAGE  
 FILTERS  
 CARBON COLUMN  
 BOOSTER PUMPS  
 FINAL FILTERS  
 200L SURGE TANK  
 CLARIFIER 2100  
 CLARIFIER 2100  
 DESLUDGE  
 DESLUDGE  
 RW IN  
 RW OUT  
 CW OUT  
 STATS WIRING AND RESTRICTION PIPE WITH SAMPLE POINTS







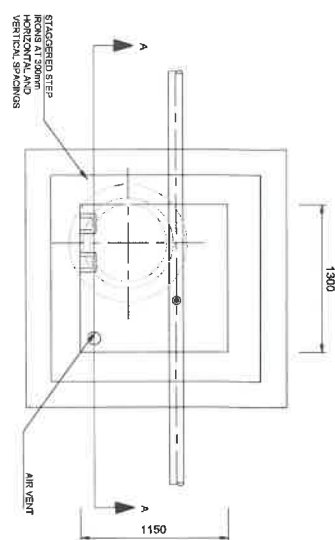

PLAN

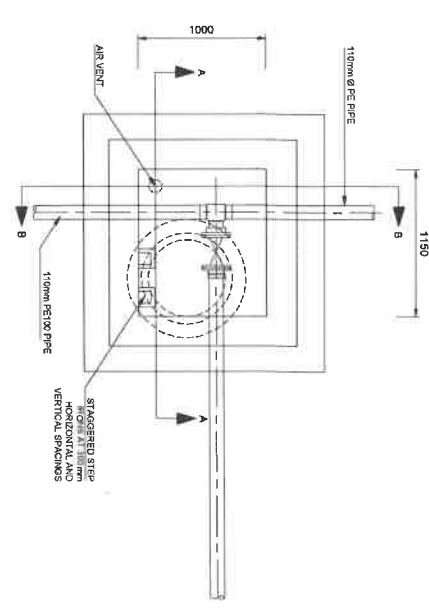

PLAN

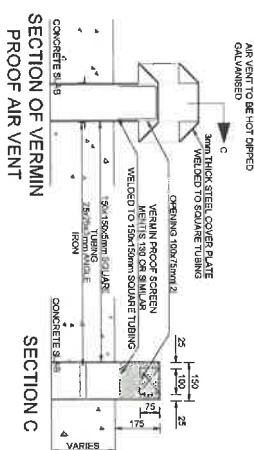
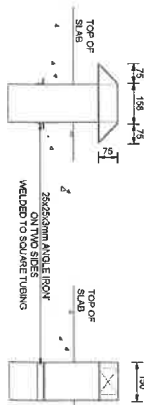

AIR VENT DETAIL  
SCALE 1:10

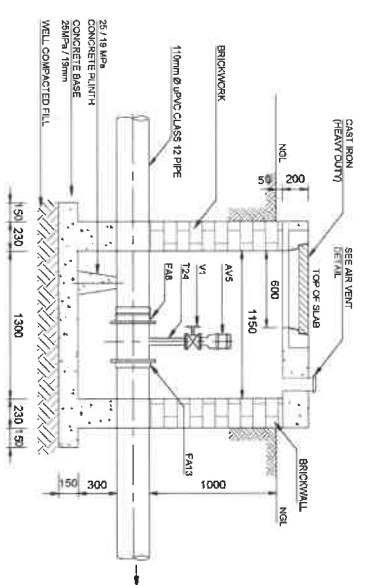

SECTION A - A  
AIR VALVE DETAIL  
NTS

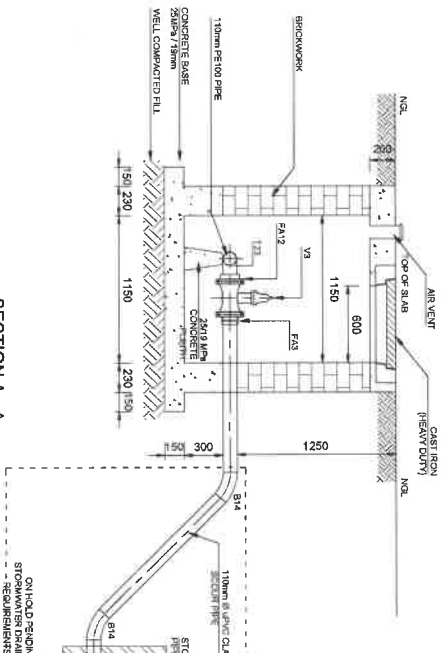

SECTION A - A  
SCOUR VALVE DETAIL  
NTS

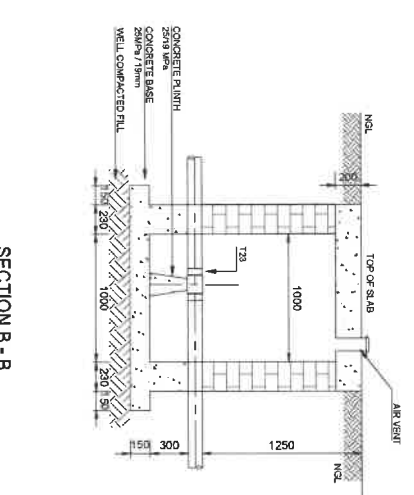

SECTION B - B  
SCOUR VALVE DETAIL  
NTS

|     |          |      |    |      |             |
|-----|----------|------|----|------|-------------|
| NO. | REVISION | DATE | BY | CHKD | DESCRIPTION |
| 1   |          |      |    |      |             |
| 2   |          |      |    |      |             |
| 3   |          |      |    |      |             |
| 4   |          |      |    |      |             |
| 5   |          |      |    |      |             |
| 6   |          |      |    |      |             |
| 7   |          |      |    |      |             |
| 8   |          |      |    |      |             |
| 9   |          |      |    |      |             |
| 10  |          |      |    |      |             |
| 11  |          |      |    |      |             |
| 12  |          |      |    |      |             |
| 13  |          |      |    |      |             |
| 14  |          |      |    |      |             |
| 15  |          |      |    |      |             |
| 16  |          |      |    |      |             |
| 17  |          |      |    |      |             |
| 18  |          |      |    |      |             |
| 19  |          |      |    |      |             |
| 20  |          |      |    |      |             |
| 21  |          |      |    |      |             |
| 22  |          |      |    |      |             |
| 23  |          |      |    |      |             |
| 24  |          |      |    |      |             |
| 25  |          |      |    |      |             |
| 26  |          |      |    |      |             |
| 27  |          |      |    |      |             |
| 28  |          |      |    |      |             |
| 29  |          |      |    |      |             |
| 30  |          |      |    |      |             |
| 31  |          |      |    |      |             |
| 32  |          |      |    |      |             |
| 33  |          |      |    |      |             |
| 34  |          |      |    |      |             |
| 35  |          |      |    |      |             |
| 36  |          |      |    |      |             |
| 37  |          |      |    |      |             |
| 38  |          |      |    |      |             |
| 39  |          |      |    |      |             |
| 40  |          |      |    |      |             |
| 41  |          |      |    |      |             |
| 42  |          |      |    |      |             |
| 43  |          |      |    |      |             |
| 44  |          |      |    |      |             |
| 45  |          |      |    |      |             |
| 46  |          |      |    |      |             |
| 47  |          |      |    |      |             |
| 48  |          |      |    |      |             |
| 49  |          |      |    |      |             |
| 50  |          |      |    |      |             |
| 51  |          |      |    |      |             |
| 52  |          |      |    |      |             |
| 53  |          |      |    |      |             |
| 54  |          |      |    |      |             |
| 55  |          |      |    |      |             |
| 56  |          |      |    |      |             |
| 57  |          |      |    |      |             |
| 58  |          |      |    |      |             |
| 59  |          |      |    |      |             |
| 60  |          |      |    |      |             |
| 61  |          |      |    |      |             |
| 62  |          |      |    |      |             |
| 63  |          |      |    |      |             |
| 64  |          |      |    |      |             |
| 65  |          |      |    |      |             |
| 66  |          |      |    |      |             |
| 67  |          |      |    |      |             |
| 68  |          |      |    |      |             |
| 69  |          |      |    |      |             |
| 70  |          |      |    |      |             |
| 71  |          |      |    |      |             |
| 72  |          |      |    |      |             |
| 73  |          |      |    |      |             |
| 74  |          |      |    |      |             |
| 75  |          |      |    |      |             |
| 76  |          |      |    |      |             |
| 77  |          |      |    |      |             |
| 78  |          |      |    |      |             |
| 79  |          |      |    |      |             |
| 80  |          |      |    |      |             |
| 81  |          |      |    |      |             |
| 82  |          |      |    |      |             |
| 83  |          |      |    |      |             |
| 84  |          |      |    |      |             |
| 85  |          |      |    |      |             |
| 86  |          |      |    |      |             |
| 87  |          |      |    |      |             |
| 88  |          |      |    |      |             |
| 89  |          |      |    |      |             |
| 90  |          |      |    |      |             |
| 91  |          |      |    |      |             |
| 92  |          |      |    |      |             |
| 93  |          |      |    |      |             |
| 94  |          |      |    |      |             |
| 95  |          |      |    |      |             |
| 96  |          |      |    |      |             |
| 97  |          |      |    |      |             |
| 98  |          |      |    |      |             |
| 99  |          |      |    |      |             |
| 100 |          |      |    |      |             |

CLIENT: MANUKA MILK PROCESSING  
LABOR & ENVIRONMENTAL SERVICES  
1001 Kaitake Road  
Newmarket, Auckland  
0622 222222

CLIENT & Structural Engineer:  
ADDISON CONSULTANTS PTY LTD  
401-414 Lakeside  
Lakeside, Auckland  
09 232 2222  
addison@addisonconsultants.com

ENGINEER: ESDR/DAVID GREENWOOD  
REGISTERED ENGINEER  
No. 11010  
11010 Lakeside  
Lakeside, Auckland  
09 232 2222  
esdr@greenwood.co.nz

DATE: 2013.01.01  
PROJECT: PROPOSED ABATTOR FOR MANUKA FARM  
DRAWING: AIR AND SCOUR VALVE CHAMBER DETAILS  
SCALE: 1:10  
SHEET: 2325 - SEW - LP - 307  
NO. OF SHEETS: 1 of 1





KOMATI RIVER

CHANNEL

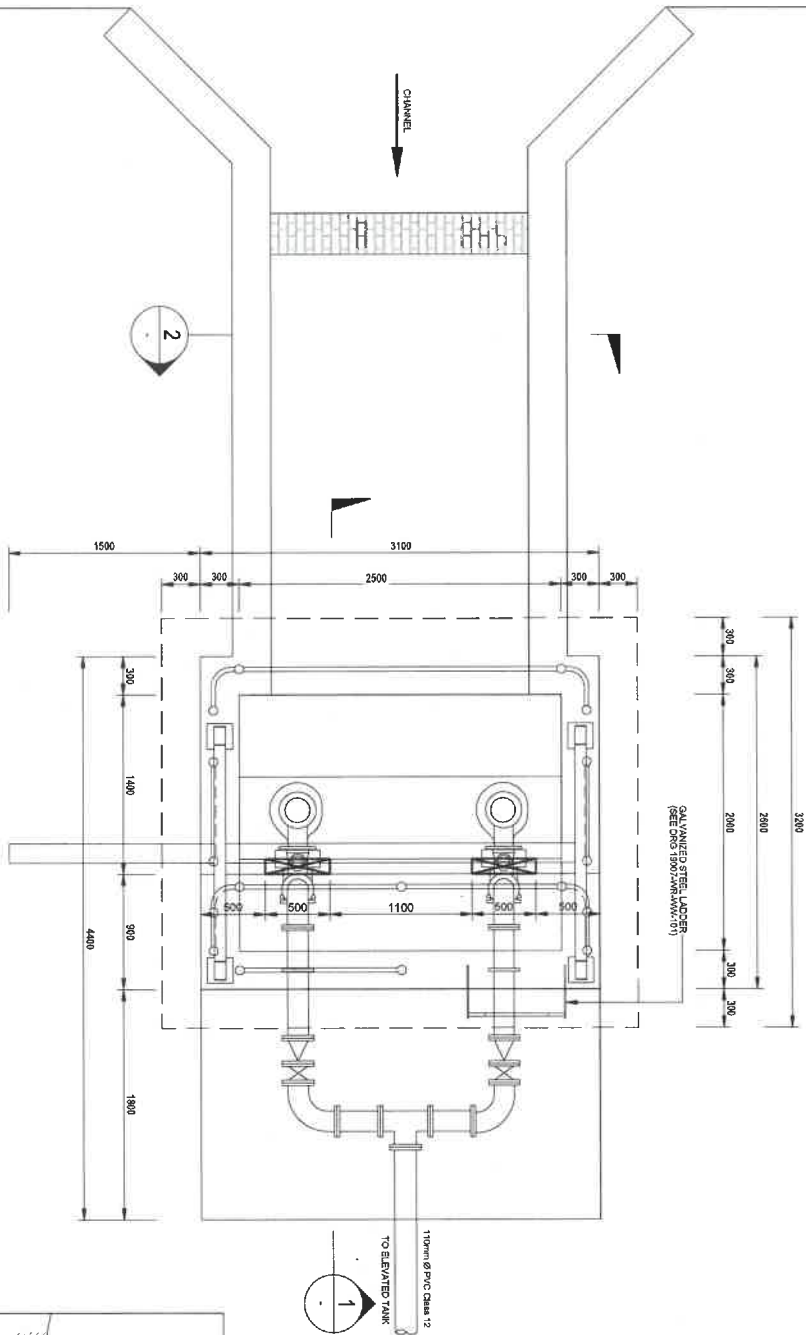

PUMP STATION PLAN  
SCALE 1:25

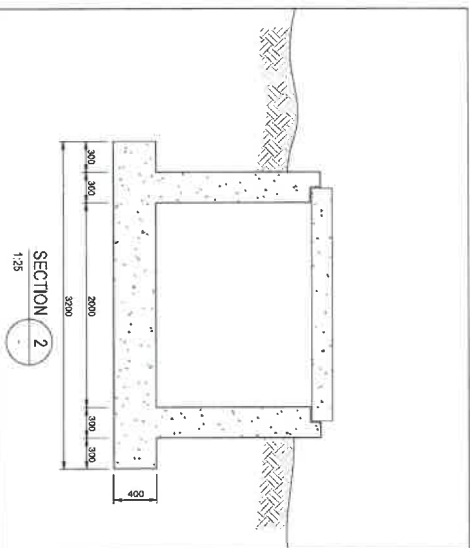

SECTION 2  
1:25

|     |            |    |      |              |
|-----|------------|----|------|--------------|
| NO. | DATE       | BY | CHKD | DESCRIPTION  |
| 1   | 2024/07/15 | MM | MM   | FINAL DESIGN |
| 2   |            |    |      |              |
| 3   |            |    |      |              |
| 4   |            |    |      |              |
| 5   |            |    |      |              |
| 6   |            |    |      |              |
| 7   |            |    |      |              |
| 8   |            |    |      |              |
| 9   |            |    |      |              |
| 10  |            |    |      |              |

CLIENT:  
MUNICIPALITY OF INKANYEZI  
LAND & ENVIRONMENTAL SERVICES  
NO. 201 0117 0000  
MUNICIPALITY OF INKANYEZI  
PO BOX 132 20110000  
11000000



DATE & STRUCTURAL ENGINEER:  
MUNICIPALITY OF INKANYEZI  
NO. 201 0117 0000  
11000000  
11000000



SCALE: AS SHOWN  
DATE: 2024/07/15  
BY: MM  
CHKD: MM

PROPOSED ABATTOIR FOR INKANYEZI FARM  
2024/07/15  
1:25

PROJECT NO: 2024/07/15  
SHEET NO: LP - 309  
OF 2

2024/07/15  
1:25  
LP - 309  
A





- NOTES AND SPECIFICATIONS**
1. ALL DIMENSIONS ARE IN MILLIMETERS UNLESS OTHERWISE SPECIFIED.
  2. ALL DIMENSIONS ARE TO FACE UNLESS OTHERWISE SPECIFIED.
  3. ALL DIMENSIONS ARE TO FACE UNLESS OTHERWISE SPECIFIED.
  4. ALL DIMENSIONS ARE TO FACE UNLESS OTHERWISE SPECIFIED.
  5. ALL DIMENSIONS ARE TO FACE UNLESS OTHERWISE SPECIFIED.
  6. ALL DIMENSIONS ARE TO FACE UNLESS OTHERWISE SPECIFIED.
  7. ALL DIMENSIONS ARE TO FACE UNLESS OTHERWISE SPECIFIED.
  8. ALL DIMENSIONS ARE TO FACE UNLESS OTHERWISE SPECIFIED.
  9. ALL DIMENSIONS ARE TO FACE UNLESS OTHERWISE SPECIFIED.
  10. ALL DIMENSIONS ARE TO FACE UNLESS OTHERWISE SPECIFIED.
- LEGEND**
- 1. ALL DIMENSIONS ARE TO FACE UNLESS OTHERWISE SPECIFIED.
  - 2. ALL DIMENSIONS ARE TO FACE UNLESS OTHERWISE SPECIFIED.
  - 3. ALL DIMENSIONS ARE TO FACE UNLESS OTHERWISE SPECIFIED.
  - 4. ALL DIMENSIONS ARE TO FACE UNLESS OTHERWISE SPECIFIED.
  - 5. ALL DIMENSIONS ARE TO FACE UNLESS OTHERWISE SPECIFIED.
  - 6. ALL DIMENSIONS ARE TO FACE UNLESS OTHERWISE SPECIFIED.
  - 7. ALL DIMENSIONS ARE TO FACE UNLESS OTHERWISE SPECIFIED.
  - 8. ALL DIMENSIONS ARE TO FACE UNLESS OTHERWISE SPECIFIED.
  - 9. ALL DIMENSIONS ARE TO FACE UNLESS OTHERWISE SPECIFIED.
  - 10. ALL DIMENSIONS ARE TO FACE UNLESS OTHERWISE SPECIFIED.

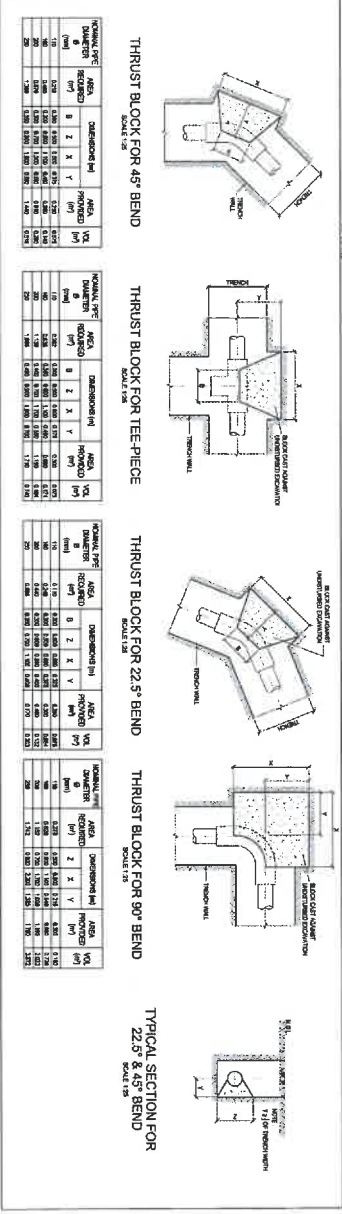
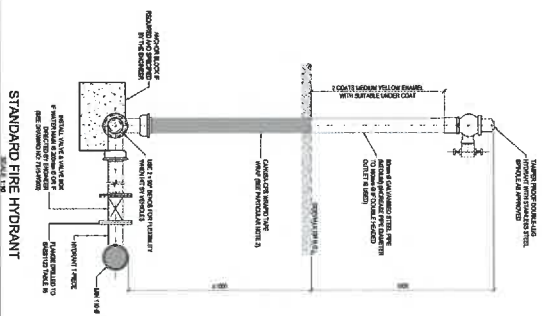
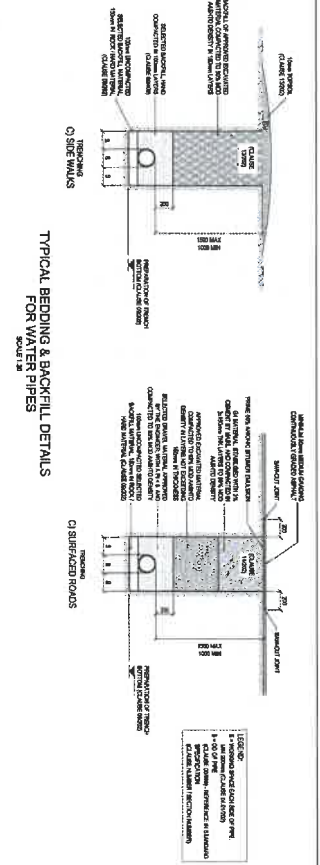

| THrust Block | 45°    | 90°    | 135°   | 180°   |
|--------------|--------|--------|--------|--------|
| Length (mm)  | 1500   | 1500   | 1500   | 1500   |
| Width (mm)   | 1500   | 1500   | 1500   | 1500   |
| Height (mm)  | 1500   | 1500   | 1500   | 1500   |
| Volume (m³)  | 0.3375 | 0.3375 | 0.3375 | 0.3375 |

| THrust Block | 45°    | 90°    | 135°   | 180°   |
|--------------|--------|--------|--------|--------|
| Length (mm)  | 1500   | 1500   | 1500   | 1500   |
| Width (mm)   | 1500   | 1500   | 1500   | 1500   |
| Height (mm)  | 1500   | 1500   | 1500   | 1500   |
| Volume (m³)  | 0.3375 | 0.3375 | 0.3375 | 0.3375 |

| THrust Block | 45°    | 90°    | 135°   | 180°   |
|--------------|--------|--------|--------|--------|
| Length (mm)  | 1500   | 1500   | 1500   | 1500   |
| Width (mm)   | 1500   | 1500   | 1500   | 1500   |
| Height (mm)  | 1500   | 1500   | 1500   | 1500   |
| Volume (m³)  | 0.3375 | 0.3375 | 0.3375 | 0.3375 |

| THrust Block | 45°    | 90°    | 135°   | 180°   |
|--------------|--------|--------|--------|--------|
| Length (mm)  | 1500   | 1500   | 1500   | 1500   |
| Width (mm)   | 1500   | 1500   | 1500   | 1500   |
| Height (mm)  | 1500   | 1500   | 1500   | 1500   |
| Volume (m³)  | 0.3375 | 0.3375 | 0.3375 | 0.3375 |

|                  |                                     |
|------------------|-------------------------------------|
| Client           | WATER SUPPLY AUTHORITY              |
| Project          | WATER SUPPLY AUTHORITY              |
| Sheet No.        | 2225 SEM-LP-312                     |
| Scale            | 1:20                                |
| Date             | 2023                                |
| Drawn By         | AT                                  |
| Checked By       | AT                                  |
| Project Location | PROPOSED ABATTOR FOR NKANKEZI FARM  |
| Sheet Title      | WATER STANDARD DETAILS SHEET 2 OF 2 |
| Revision         | 2225 SEM-LP-312                     |
| Author           | AT                                  |
| Checker          | AT                                  |

**FOR-ENG**  
Engineering Solutions

3023, 25, JARAT

### RECORD OF ADDENDUM TO BID DOCUMENTS

We confirm that the following communications received from the Employer before the submission of this Bid Offer, amending the Bid Documents, have been taken into account in this Bid Offer:

|    | Date | Title or Details |
|----|------|------------------|
| 1. |      |                  |
| 2. |      |                  |
| 3. |      |                  |
| 4. |      |                  |
| 5. |      |                  |
| 6. |      |                  |
| 7. |      |                  |
| 8. |      |                  |

Attach additional pages if more space is required.

Signed

Date

Name

Position

Service  
Provider

### CERTIFICATE OF AUTHORITY OF AN ENTITY

Indicate the status of the service provider by ticking the appropriate box hereunder. The service provider must complete the Certificate set out below for the relevant category.

| (I)<br>Company | (II)<br>Close<br>Corporation | (III)<br>Partnership | (IV)<br>Joint Venture | (V)<br>Sole Proprietor |
|----------------|------------------------------|----------------------|-----------------------|------------------------|
|                |                              |                      |                       |                        |

**(I) CERTIFICATE FOR COMPANY**

I ....., chairperson of the Board of Directors of  
....., hereby confirm that by resolution of the Board (copy attached)  
taken on ..... 20.....,

Mr/Ms ....., acting in the capacity of  
....., was authorised to sign all Documents in  
connection with this Bid and any Contract resulting from it on behalf of the Company.

**Signature of Chairman:** .....

**Signature of Signatory:** .....

**As Witnesses:**

1..... Name in Block Letters.....

2..... Name in Block Letters.....

**Date:** .....

---

### COMPULSORY ENTERPRISE QUESTIONNAIRE

The following particulars must be furnished. In the case of a Joint Venture, **separate** Enterprise questionnaires in respect of each Partner must be completed and submitted.

**Section 1: Name of Enterprise:** .....

**Section 2: VAT registration number, if any:** .....

**Section 3: CIDB registration number, if any:** .....

**Section 4: Particulars of Sole Proprietors and Partners in Partnerships**

| Name* | Identity number* | Personal income tax number* |
|-------|------------------|-----------------------------|
|       |                  |                             |
|       |                  |                             |
|       |                  |                             |

\* Complete only if Sole Proprietor or Partnership and attach separate page if more than 3 Partners

**Section 5: Particulars of Companies and Close Corporations**

Company registration number .....

Close Corporation number .....

Tax reference number .....

**Section 6: Record in the service of the State**

Indicate by marking the relevant boxes with a cross, if any Sole Proprietor, Partner in a Partnership or Director, Manager, Principal Shareholder or Stakeholder in a Company or Close Corporation is currently or has been within the last 12 months in the service of any of the following:

- |   |  |
|---|--|
| <ul style="list-style-type: none"> <li>a Member of any Municipal Council</li> <li>a Member of any Provincial Legislature</li> <li>a Member of the National Assembly or the National Council of Province</li> <li>a Member of the Board of Directors of any Municipal entity</li> <li>an Official of any Municipality or Municipal entity</li> </ul> | <ul style="list-style-type: none"> <li>an employee of any Provincial Department, National or Provincial Public entity or Constitutional Institution within the meaning of the Public Finance Management Act, 1999 (Act 1 of 1999)</li> <li>a Member of an Accounting Authority of any National or Provincial Public Entity</li> <li>an employee of Parliament or a Provincial Legislature</li> </ul> |
|---|--|

**If any of the above boxes are marked, disclose the following:**

| Name of Sole Proprietor, Partner, Director, Manager, Principal Shareholder or Stakeholder | Name of Institution, Public Office, board or organ of State and position held | Status of service (tick appropriate column) |                       |
|---|---|---|-----------------------|
|   |   | Current                                     | Within last 12 months |
|   |   |   |                       |
|   |   |   |                       |
|   |   |   |                       |
|   |   |   |                       |
|   |   |   |                       |

\*insert separate page if necessary

**Section 7: Record of spouses, children and parents in the service of the State**

Indicate by marking the relevant boxes with a cross, if any spouse, child or parent of a Sole Proprietor, Partner in a

Partnership or Director, Manager, Principal Shareholder or Stakeholder in a Company or Close Corporation is currently or has been within the last 12 months been in the service of any of the following:

- |   |  |
|---|--|
| a Member of any Municipal Council                                     | an employee of any Provincial Department, National or Provincial Public Entity or Constitutional Institution within the meaning of the Public Finance Management Act, 1999 (Act 1 of 1999) |
| a Member of any Provincial Legislature                                | a Member of an Accounting Authority of any National or Provincial Public entity  |
| a Member of the National Assembly or the National Council of Province | an employee of Parliament or a Provincial Legislature  |
| a Member of the Board of Directors of any Municipal Entity            |  |
| an Official of any Municipality or Municipal entity                   |  |

| Name of spouse, child or parent | Name of Institution, Public Office, Board or Organ of State and position held | Status of service (tick appropriate column) |                       |
|---------------------------------|---|---|-----------------------|
|                                 |   | Current                                     | Within last 12 months |
|                                 |   |   |                       |
|                                 |   |   |                       |
|                                 |   |   |                       |
|                                 |   |   |                       |
|                                 |   |   |                       |
|                                 |   |   |                       |

\*insert separate page if necessary

The undersigned, who warrants that he / she is duly authorised to do so on behalf of the Enterprise:

- i) authorizes the Employer to obtain a tax clearance Certificate from the South African Revenue Services that my / our tax matters are in order;
- ii) confirms that the neither the name of the Enterprise or the name of any Partner, Manager, Director or other Person, who wholly or partly exercises, or may exercise, control over the Enterprise appears on the Register of Bid Defaulters established in terms of the Prevention and Combating of Corrupt Activities Act of 2004;
- iii) confirms that no Partner, Member, Director or other Person, who wholly or partly exercises, or may exercise, control over the Enterprise appears, has within the last five years been convicted of fraud or corruption;
- iv) confirms that I / we are not associated, linked or involved with any other Biding entities submitting Bid Offers and have no other relationship with any of the Biders or those responsible for compiling the Scope of Work that could cause or be interpreted as a conflict of interest; and
- iv) confirms that the contents of this questionnaire are within my personal knowledge and are to the best of my belief both true and correct.

Signed

Date

Name

Position

Enterprise  
Name

**SCHEDULE OF THE SERVICE PROVIDERS EXPERIENCE**

The following is a Statement of Work of similar nature recently successfully executed by myself / ourselves:

| <b>EXPERIENCE</b> | <b>Employer:<br/>Contact<br/>Person and<br/>Telephone<br/>Number</b> | <b>Consulting<br/>Engineer:<br/>Contact<br/>Person and<br/>Telephone<br/>Number</b> | <b>Nature of Work</b> | <b>Value of Work<br/>(inclusive of VAT)</b> | <b>Date<br/>Completed</b>                  |
|-------------------|--|---|-----------------------|---|--|
| 1                 |  |   |                       |   |  |
|                   |  |   |                       |   |  |
|                   |  |   |                       |   |  |
| 2                 |  |   |                       |   |  |
|                   |  |   |                       |   |  |
|                   |  |   |                       |   |  |
| 3                 |  |   |                       |   |  |
|                   |  |   |                       |   |  |
|                   |  |   |                       |   |  |
| 4                 |  |   |                       |   |  |
|                   |  |   |                       |   |  |
|                   |  |   |                       |   |  |
| <b>CURRENT</b>    | <b>Employer</b>  | <b>Engineer</b>   | <b>Nature of Work</b> | <b>Value of Work (VAT<br/>Inclusive)</b>    | <b>Contractual<br/>completion<br/>Date</b> |
| 1                 |  |   |                       |   |  |
|                   |  |   |                       |   |  |
|                   |  |   |                       |   |  |
| 2                 |  |   |                       |   |  |
|                   |  |   |                       |   |  |
|                   |  |   |                       |   |  |
| 3                 |  |   |                       |   |  |
|                   |  |   |                       |   |  |
|                   |  |   |                       |   |  |
| 4                 |  |   |                       |   |  |
|                   |  |   |                       |   |  |
|                   |  |   |                       |   |  |

SIGNATURE: .....

DATE: .....

*(of person authorised to sign on behalf of the service provider)*

**KEY PERSONNEL**

In terms of the Project Specification and the Conditions of Bid, unskilled Workers may only be brought in from outside the Local Community if such personnel are not available locally.

**The service provider shall list below the personnel which he intends to utilize on the Works, including key personnel which may have to be brought in from outside if not available locally.**

| Category of Employee                          | Number of Persons                                    |         |   |         |  |         |
|---|--|---------|---|---------|--|---------|
|   | Key Personnel, Part of the Contractor's Organisation |         | Key Personnel to be imported if not available locally |         | Unskilled Personnel to be recruited from local community |         |
|   | HDI  | NON-HDI | HDI   | NON-HDI | HDI  | NON-HDI |
| Site Agent, Project Managers                  |  |         |   |         |  |         |
| Foremen, Quality Control and Safety Personnel |  |         |   |         |  |         |
| Technicians, Surveyors, etc                   |  |         |   |         |  |         |
| Artisans and other Skilled Workers            |  |         |   |         |  |         |
| Plant Operators                               |  |         |   |         |  |         |
| Unskilled Workers                             |  |         |   |         |  |         |
| Others:                                       |  |         |   |         |  |         |
| .....   | .....  | .....   | .....   | .....   | .....  | .....   |
| .....   | .....  | .....   | .....   | .....   | .....  | .....   |
| .....   | .....  | .....   | .....   | .....   | .....  | .....   |
| .....   | .....  | .....   | .....   | .....   | .....  | .....   |
| .....   | .....  | .....   | .....   | .....   | .....  | .....   |

SIGNATURE: .....  
*(of person authorised to sign on behalf of the service provider)*

DATE: .....

**CURRICULUM VITAE FORMAT OF KEY PERSONNEL  
(e.g. Contract Manager)**

|  |                         |
|--|-------------------------|
| <b>Name:</b>   | <b>Date of birth:</b>   |
| <b>Profession:</b>   | <b>Nationality:</b>     |
| <b>Qualifications:</b>   |                         |
| <b>Professional Registration Number:</b>                       |                         |
| <b>Name of Employer (firm):</b>                                |                         |
| <b>Current position:</b>                                       | <b>Years with firm:</b> |
| <b><u>Employment Record:</u></b>                               |                         |
|  |                         |
|  |                         |
|  |                         |
|  |                         |
|  |                         |
|  |                         |
|  |                         |
|  |                         |
|  |                         |
|  |                         |
|  |                         |
|  |                         |
| <b><u>Experience Record Pertinent to Required service:</u></b> |                         |
|  |                         |
|  |                         |
|  |                         |
|  |                         |
|  |                         |
|  |                         |
|  |                         |
|  |                         |
|  |                         |
|  |                         |

**Certification:**

I, the undersigned, certify that, to the best of my knowledge and belief, this data correctly describes me, my qualifications and my experience.

.....  
*Signature of person named in the Schedule*

.....  
*Date*

**CURRICULUM VITAE FORMAT OF KEY PERSONNEL  
(e.g. Site Agent)**

|  |                         |
|--|-------------------------|
| <b>Name:</b>   | <b>Date of birth:</b>   |
| <b>Profession:</b>   | <b>Nationality:</b>     |
| <b>Qualifications:</b>   |                         |
| <b>Professional Registration Number:</b>                       |                         |
| <b>Name of Employer (firm):</b>                                |                         |
| <b>Current position:</b>                                       | <b>Years with firm:</b> |
| <b><u>Employment Record:</u></b>                               |                         |
|  |                         |
|  |                         |
|  |                         |
|  |                         |
|  |                         |
|  |                         |
|  |                         |
|  |                         |
|  |                         |
|  |                         |
|  |                         |
| <b><u>Experience Record Pertinent to Required service:</u></b> |                         |
|  |                         |
|  |                         |
|  |                         |
|  |                         |
|  |                         |
|  |                         |
|  |                         |
|  |                         |
|  |                         |
|  |                         |
|  |                         |

**Certification:**

I, the undersigned, certify that, to the best of my knowledge and belief, this data correctly describes me, my qualifications and my experience.

.....  
*Signature of person named in the Schedule*

.....  
*Date*

**CURRICULUM VITAE FORMAT OF KEY PERSONNEL  
(e.g. General Foreman)**

|  |                         |
|--|-------------------------|
| <b>Name:</b>   | <b>Date of birth:</b>   |
| <b>Profession:</b>   | <b>Nationality:</b>     |
| <b>Qualifications:</b>   |                         |
| <b>Professional Registration Number:</b>                       |                         |
| <b>Name of Employer (firm):</b>                                |                         |
| <b>Current position:</b>                                       | <b>Years with firm:</b> |
| <b><u>Employment Record:</u></b>                               |                         |
|  |                         |
|  |                         |
|  |                         |
|  |                         |
|  |                         |
|  |                         |
|  |                         |
|  |                         |
|  |                         |
|  |                         |
|  |                         |
| <b><u>Experience Record Pertinent to Required service:</u></b> |                         |
|  |                         |
|  |                         |
|  |                         |
|  |                         |
|  |                         |
|  |                         |
|  |                         |
|  |                         |
|  |                         |
|  |                         |
|  |                         |

**Certification:**

I, the undersigned, certify that, to the best of my knowledge and belief, this data correctly describes me, my qualifications and my experience.

.....  
*Signature of person named in the Schedule*

.....  
*Date*

**CURRICULUM VITAE FORMAT OF KEY PERSONNEL  
(e.g. Any Other)**

|  |                         |
|--|-------------------------|
| <b>Name:</b>   | <b>Date of birth:</b>   |
| <b>Profession:</b>   | <b>Nationality:</b>     |
| <b>Qualifications:</b>   |                         |
| <b>Professional Registration Number:</b>                       |                         |
| <b>Name of Employer (firm):</b>                                |                         |
| <b>Current position:</b>                                       | <b>Years with firm:</b> |
| <b><u>Employment Record:</u></b>                               |                         |
|  |                         |
|  |                         |
|  |                         |
|  |                         |
|  |                         |
|  |                         |
|  |                         |
|  |                         |
|  |                         |
|  |                         |
|  |                         |
| <b><u>Experience Record Pertinent to Required service:</u></b> |                         |
|  |                         |
|  |                         |
|  |                         |
|  |                         |
|  |                         |
|  |                         |
|  |                         |
|  |                         |
|  |                         |
|  |                         |
|  |                         |

**Certification:**

I, the undersigned, certify that, to the best of my knowledge and belief, this data correctly describes me, my qualifications and my experience.

.....  
*Signature of person named in the Schedule*

.....  
*Date*

### AMENDMENTS, DEVIATIONS AND ALTERNATIVES

*(This is not an invitation for amendments, deviations or alternatives, but should the service provider desire to make any departures from the Provisions of this Contract he shall set out his proposals clearly hereunder. The Employer will not consider any amendment, unless form (a), has been completed to the satisfaction of the Employer). The service provider is referred to Bid Data paragraph F.2.12, where it is clearly stated that no Alternative Offers will be accepted.*

I / We herewith propose the amendments, as set out in the table below:

**(a) AMENDMENTS**

| PAGE, CLAUSE OR<br>ITEM NO | PROPOSED AMENDMENT |
|----------------------------|--------------------|
|                            |                    |
|                            |                    |
|                            |                    |
|                            |                    |
|                            |                    |
|                            |                    |

- Notes:** (1) Amendments to the General and Special Conditions of Contract are not acceptable;
- (2) The service provider must give full details of all the financial implications of the amendments and qualifications in a covering letter attached to his Bid.
-

**SCHEDULE OF PROPOSED SUPPLIERS AND SUB-CONTRACTORS**

We notify you that it is our intention to employ the following Suppliers and Subcontractors for Work in this Contract. If we are awarded a Contract we agree that this notification does not change the requirement for us to submit the names of proposed Suppliers and Subcontractors in accordance with requirements in the Contract for such appointments. If there are no such requirements in the Contract, then your written acceptance of this list shall be binding between us.

We confirm that all Subcontractors who are Contracted to construct a house are registered as Home Builders with the National Home Builders Registration Council.

|           | <b>Name and address of proposed Supplier</b>      | <b>Name of Equipment/Material to Supply</b> | <b>Previous experience with Supplier.</b>      |
|-----------|---|---|--|
| <b>1</b>  |   |   |  |
| <b>2</b>  |   |   |  |
| <b>3</b>  |   |   |  |
| <b>4</b>  |   |   |  |
|           | <b>Name and address of proposed Subcontractor</b> | <b>Nature and extent of Work</b>            | <b>Previous experience with Subcontractor.</b> |
| <b>1.</b> |   |   |  |
| <b>2.</b> |   |   |  |

Signed \_\_\_\_\_ Date \_\_\_\_\_

Name \_\_\_\_\_ Position \_\_\_\_\_

Service provider \_\_\_\_\_

### SCHEDULE OF PLANT AND EQUIPMENT

The following are lists of major items of relevant equipment that I / we presently own or lease and will have available for this Contract or will acquire or hire for this Contract if my / our Bid is accepted.

(a) Details of major equipment that is owned by and immediately available for this Contract.

| Quantity | Description, size, capacity, etc. |
|----------|-----------------------------------|
|          |                                   |

Attach additional pages if more space is required.

(b) Details of major equipment that will be hired, or acquired for this Contract if my / our Bid is acceptable.

| Quantity | Description, size, capacity, etc. |
|----------|-----------------------------------|
|          |                                   |

Attach additional pages if more space is required.

Signed

Date

Name

Position

Service  
provider

**COPY OF WORKMEN'S COMPENSATION REGISTRATION CERTIFICATE (OR PROOF OF PAYMENT OF CONTRIBUTIONS IN TERMS OF THE COMPENSATION FOR OCCUPATIONAL INJURIES AND DISEASES ACT NO. 130 OF 1993)**

*[Certified Copy of the Certificate or Proof of Payment thereof obtained from the Workmen's Compensation Commissioner to be inserted here]*

---

## **CIDB GRADING CERTIFICATE**

***[Certified Copy of the CIDB Grading Certificate to be inserted here]***

---

### EXECUTION PROGRAMME

The service provider shall detail below or attach a preliminary programme reflecting the proposed sequence and tempo of execution of the various activities comprising the Work for this Contract. The programme shall be in accordance with the information supplied in the Contract, requirements of the Project Specifications and with all other aspects of his Bid.

The Execution Programme must be based on the completion time as specified in the Contract Data.

**PLEASE NOTE:** the cash flow projections from the Contractor (to be submitted before commencement of the execution of the Contract) must be in accordance with this execution plan in order to ensure proper Cash flow management by the Department and to minimise delayed payments.

| PROGRAMME |       |   |   |   |   |   |   |   |   |    |    |    |    |    |
|-----------|-------|---|---|---|---|---|---|---|---|----|----|----|----|----|
| ACTIVITY  | WEEKS |   |   |   |   |   |   |   |   |    |    |    |    |    |
|           | 1     | 2 | 3 | 4 | 5 | 6 | 7 | 8 | 9 | 10 | 11 | 12 | 13 | 14 |
|           |       |   |   |   |   |   |   |   |   |    |    |    |    |    |
|           |       |   |   |   |   |   |   |   |   |    |    |    |    |    |
|           |       |   |   |   |   |   |   |   |   |    |    |    |    |    |
|           |       |   |   |   |   |   |   |   |   |    |    |    |    |    |
|           |       |   |   |   |   |   |   |   |   |    |    |    |    |    |
|           |       |   |   |   |   |   |   |   |   |    |    |    |    |    |
|           |       |   |   |   |   |   |   |   |   |    |    |    |    |    |
|           |       |   |   |   |   |   |   |   |   |    |    |    |    |    |
|           |       |   |   |   |   |   |   |   |   |    |    |    |    |    |
|           |       |   |   |   |   |   |   |   |   |    |    |    |    |    |
|           |       |   |   |   |   |   |   |   |   |    |    |    |    |    |
|           |       |   |   |   |   |   |   |   |   |    |    |    |    |    |
|           |       |   |   |   |   |   |   |   |   |    |    |    |    |    |
|           |       |   |   |   |   |   |   |   |   |    |    |    |    |    |
|           |       |   |   |   |   |   |   |   |   |    |    |    |    |    |
|           |       |   |   |   |   |   |   |   |   |    |    |    |    |    |

SIGNATURE: .....  
 (of person authorised to sign on behalf of the service provider)

DATE: .....

### DETAILED METHOD STATEMENT

The service provider shall detail below or attach a detailed method statement reflecting the proposed sequence and tempo of execution of the various activities comprising the Work for this Contract. The Method Statement shall be read in conjunction with the works program but detailing and expanding on all the items leading to the completion of the works and the resource allocation.

SIGNATURE: .....  
*(of person authorised to sign on behalf of the service provider)*

DATE: .....

---



(b) Details of training of persons from my Company's own resources (or to be hired) who still have to be trained to achieve the necessary competency:

(i) By whom will training be provided? .....

(ii) When will training be undertaken? .....

(iii) List the positions to be filled by persons to be trained or hired: .....

.....

.....

.....

(c) Details of competent resources to be appointed as Subcontractors if Competent Persons cannot be supplied from own Company:

Name of proposed Subcontractor: .....

Qualifications or details of competency of the Subcontractor: .....

.....

.....

.....

5. I hereby undertake, if my Bid is accepted, to provide, before commencement of the Works under the Contract, a suitable and sufficiently Documented Health and Safety Plan in accordance with Regulation 5(1) of the Construction Regulations, which plan shall be subject to approval by the Employer.

6. I confirm that copies of my Company's approved Health and Safety Plan, the Employer's Safety Specifications as well as the OHSA 1993 Construction Regulations 2003 will be provided on Site and will at all times be available for inspection by the Contractor's personnel, the Employer's personnel, the Engineer, visitors, and Officials and Inspectors of the Department of Labour.

7. I hereby confirm that adequate provision has been made in my Bided rates and prices in the Schedule of Quantities to cover the cost of all resources, actions, training and all health and safety measures envisaged in the OHSA 1993 Construction Regulations 2003, and that I will be liable for any penalties that may be applied by the Employer in terms of the said Regulations (Regulation 30) for failure on the Contractor's part to comply with the Provisions of the Act and the Regulations.

8. I agree that my failure to complete and execute this declaration to the satisfaction of the Employer will mean that I am unable to comply with the requirements of the OHSA 1993 Construction Regulations 2003, and accept that my Bid will be prejudiced and may be rejected at the discretion of the Employer.

SIGNATURE: .....  
(of person authorised to sign on behalf of the service provider)

DATE: .....

---

## CONTRACTOR'S SAFETY PLAN

***[The Contractor shall submit the Contractor's Health and Safety Plan as required in terms of Regulation 5 of the Occupational Health and Safety Act 1993 Construction Regulations 2003, and referred to in T2.1, before commencement of the Works.]***

---

**PRO FORMA NOTIFICATION FORM IN TERMS OF THE OCCUPATIONAL HEALTH AND SAFETY ACT 1993,  
CONSTRUCTION REGULATIONS 2003**

*[This form must be completed and forwarded, prior to commencement of Work on Site, by all Contractors that qualify in terms of Regulation 3 of the Construction Regulations 2003, to the Office of the Department of Labour]*

1. (a) Name and postal address of Contractor:.....  
.....
- (b) Name of Contractor's contact person: .....  
Telephone number: .....
2. Contractor's Workman's compensation registration number: .....
3. (a) Name and postal address of Client: .....  
.....
- (b) Name of Client's contact person or Agent: .....  
Telephone number.....
4. (a) Name and postal address of designer(s) for the Project: .....  
.....
- (b) Name of Designer's contact person: .....  
Telephone number.....
5. Name of Contractor's Construction Supervisor on Site appointed in terms of Regulation 6(1): ..... Telephone number: .....
6. Name/s of Contractor's sub-ordinate supervisors on Site appointed in terms of Regulation 6(2).  
.....
7. Exact physical address of the construction Site or Site Office:.....  
.....
8. Nature of the construction Work: .....  
.....
9. Expected Commencement Date: .....
10. Expected Completion Date: .....
11. Estimated maximum number of persons on the construction Site: .....
12. Planned number of Subcontractors on the construction Site accountable to Contractor: .....
13. Name(s) of Subcontractors already chosen: .....  
.....  
.....  
.....

SIGNED BY:

CONTRACTOR: ..... DATE: .....

CLIENT: ..... DATE: .....

---

## MONTHLY LABOUR REPORT

MONTHLY LABOUR REPORT FOR CERTIFICATE OF PAYMENT NO. ....

JOBS CREATED.....

**Jobs are to be reported on a monthly basis on following standard documents:**

- EPWP Agreement - Limited Duration Contract of Employment (template to be provided by the Employer)
- Certified ID copies (not older than six (6) months from date of employment) of all employees under the contract
- Signed and dated monthly EPWP timesheets per employee (template to be provided by the Employer)

The Service Provider is required to submit CVs (including certified proof of qualification(s)) and Contact Details of all key personnel upon appointment or during the Site Handover.

---

**SIGNATURE:** \_\_\_\_\_

**WITNESS No. 1** \_\_\_\_\_

**DATE:** \_\_\_\_\_

**WITNESS No. 2** \_\_\_\_\_

**DATE:** \_\_\_\_\_



Annex D

Imported Content Declaration - Supporting Schedule to Annex C

(D1) Tender No.  
 (D2) Tender description:  
 (D3) Designated Products:  
 (D4) Tender Authority:  
 (D5) Tendering Entity name:  
 (D6) Tender Exchange Rate: Pula

Note: VAT to be excluded from all calculations

EU R 9.00 GBP R 12.00

A. Exempted imported content

| Tender Item no's                  | Description of imported content | Local supplier | Overseas Supplier | Calculation of imported content                  |                      |                        |                                |   |                            | Summary    |                         |
|-----------------------------------|---------------------------------|----------------|-------------------|--|----------------------|------------------------|--------------------------------|---|----------------------------|------------|-------------------------|
|                                   |                                 |                |                   | Foreign currency value as per Commercial Invoice | Tender Exchange Rate | Local value of Imports | Freight costs to port of entry | All locally incurred landing costs & duties | Total landed cost excl VAT | Tender Qty | Exempted imported value |
| (D7)                              | (D8)                            | (D9)           | (D10)             | (D11)  | (D12)                | (D13)                  | (D14)                          | (D15)                                       | (D16)                      | (D17)      | (D18)                   |
|                                   |                                 |                |                   |  |                      |                        |                                |   |                            |            |                         |
| (D19) Total exempt imported value |                                 |                |                   |  |                      |                        |                                |   |                            |            | R 0                     |

This total must correspond with Annex C - C 21

B. Imported directly by the Tenderer

| Tender Item no's                       | Description of imported content | Unit of measure | Overseas Supplier | Calculation of imported content                  |                         |                        |                                |   |                            | Summary    |                      |
|--|---------------------------------|-----------------|-------------------|--|-------------------------|------------------------|--------------------------------|---|----------------------------|------------|----------------------|
|  |                                 |                 |                   | Foreign currency value as per Commercial Invoice | Tender Rate of Exchange | Local value of Imports | Freight costs to port of entry | All locally incurred landing costs & duties | Total landed cost excl VAT | Tender Qty | Total imported value |
| (D20)                                  | (D21)                           | (D22)           | (D23)             | (D24)  | (D25)                   | (D26)                  | (D27)                          | (D28)                                       | (D29)                      | (D30)      | (D31)                |
|  |                                 |                 |                   |  |                         |                        |                                |   |                            |            |                      |
| (D32) Total imported value by tenderer |                                 |                 |                   |  |                         |                        |                                |   |                            |            | R 0                  |

C. Imported by a 3rd party and supplied to the Tenderer

| Description of imported content         | Unit of measure | Local supplier | Overseas Supplier | Calculation of imported content                  |                         |                        |                                |   |                            | Summary           |                      |
|---|-----------------|----------------|-------------------|--|-------------------------|------------------------|--------------------------------|---|----------------------------|-------------------|----------------------|
|   |                 |                |                   | Foreign currency value as per Commercial Invoice | Tender Rate of Exchange | Local value of Imports | Freight costs to port of entry | All locally incurred landing costs & duties | Total landed cost excl VAT | Quantity imported | Total imported value |
| (D33)                                   | (D34)           | (D35)          | (D36)             | (D37)  | (D38)                   | (D39)                  | (D40)                          | (D41)                                       | (D42)                      | (D43)             | (D44)                |
|   |                 |                |                   |  |                         |                        |                                |   |                            |                   |                      |
| (D45) Total imported value by 3rd party |                 |                |                   |  |                         |                        |                                |   |                            |                   | R 0                  |

D. Other foreign currency payments

| Type of payment | Local supplier making the payment | Overseas beneficiary | Calculation of foreign currency payments |                         | Summary of payments |
|-----------------|-----------------------------------|----------------------|--|-------------------------|---------------------|
|                 |                                   |                      | Foreign currency value paid              | Tender Rate of Exchange |                     |
| (D46)           | (D47)                             | (D48)                | (D49)                                    | (D50)                   | (D51)               |
|                 |                                   |                      |  |                         |                     |
|                 |                                   |                      |  |                         |                     |
|                 |                                   |                      |  |                         |                     |

(D52) Total of foreign currency payments declared by tenderer and/or 3rd party

(D53) Total of imported content & foreign currency payments - (D32), (D45) & (D52) above R 0

Signature of tenderer from Annex B

Date:

This total must correspond with Annex C - C 23

## Annex E

### Local Content Declaration - Supporting Schedule to Annex C

|      |                        |  |
|------|------------------------|--|
| (E1) | Tender No.             | <input style="width: 90%;" type="text"/> |
| (E2) | Tender description:    | <input style="width: 90%;" type="text"/> |
| (E3) | Designated products:   | <input style="width: 90%;" type="text"/> |
| (E4) | Tender Authority:      | <input style="width: 90%;" type="text"/> |
| (E5) | Tendering Entity name: | <input style="width: 90%;" type="text"/> |

**Note: VAT to be excluded from all calculations**

| Local Products<br>(Goods, Services and Works)                | Description of items purchased | Local suppliers | Value |
|--|--------------------------------|-----------------|-------|
|  | (E6)                           | (E7)            | (E8)  |
|  |                                |                 |       |
|  |                                |                 |       |
|  |                                |                 |       |
|  |                                |                 |       |
|  |                                |                 |       |
|  |                                |                 |       |
|  |                                |                 |       |
|  |                                |                 |       |
|  |                                |                 |       |
|  |                                |                 |       |
|  |                                |                 |       |
|  |                                |                 |       |
| <b>(E9) Total local products (Goods, Services and Works)</b> |                                |                 | R 0   |

|                                  |   |  |  |
|----------------------------------|---|--|--|
| (E10)                            | <b>Manpower costs</b>                       | (Tenderer's manpower cost)   | <input style="width: 80%;" type="text"/> R 0 |
| (E11)                            | <b>Factory overheads</b>                    | (Rental, depreciation & amortisation, utility costs, consumables etc.) | <input style="width: 80%;" type="text"/> R 0 |
| (E12)                            | <b>Administration overheads and mark-up</b> | (Marketing, insurance, financing, interest etc.)                       | <input style="width: 80%;" type="text"/> R 0 |
| <b>(E13) Total local content</b> |   |  | <input style="width: 80%;" type="text"/> R 0 |

**This total must correspond with Annex C - C24**

Signature of tenderer from Annex B

Date: \_\_\_\_\_



### Application for a Tax Clearance Certificate

**Purpose**

Select the applicable option .....Tenders  Good standing

If "Good standing", please state the purpose of this application

Two empty text input boxes for stating the purpose of the application.

**Particulars of applicant**

Name/Legal name (Initials & Surname or registered name) [Grid]

Trading name (if applicable) [Grid]

ID/Passport no [Grid] Company/Close Corp. registered no [Grid]

Income Tax ref no [Grid] PAYE ref no 7 [Grid]

VAT registration no 4 [Grid] SDL ref no L [Grid]

Customs code [Grid] UIF ref no U [Grid]

Telephone no [Grid] Fax no [Grid]

E-mail address [Grid]

Physical address [Grid]

Postal address [Grid]

**Particulars of representative (Public Officer/Trustee/Partner)**

Surname [Grid]

First names [Grid]

ID/Passport no [Grid] Income Tax ref no [Grid]

Telephone no [Grid] Fax no [Grid]

E-mail address [Grid]

Physical address [Grid]

**Particulars of tender** (If applicable)

Tender number

Estimated Tender amount R

Expected duration of the tender  year(s)

**Particulars of the 3 largest contracts previously awarded**

| Date started | Date finalised | Principal | Contact person | Telephone number | Amount |
|--------------|----------------|-----------|----------------|------------------|--------|
|--------------|----------------|-----------|----------------|------------------|--------|

**Audit**

Are you currently aware of any Audit investigation against you/the company?  YES  NO  
If "YES" provide details

**Appointment of representative/agent (Power of Attorney)**

I the undersigned confirm that I require a Tax Clearance Certificate in respect of  Tenders or  Goodstanding.

I hereby authorise and instruct  to apply to and receive from SARS the applicable Tax Clearance Certificate on my/our behalf.

Signature of representative/agent

--

Date

Name of representative/agent

**Declaration**

I declare that the information furnished in this application as well as any supporting documents is true and correct in every respect.

Signature of applicant/Public Officer

--

Date

Name of applicant/Public Officer

**Notes:**

1. It is a serious offence to make a false declaration.
2. Section 75 of the Income Tax Act, 1962, states: Any person who
  - (a) fails or neglects to furnish, file or submit any return or document as and when required by or under this Act; or
  - (b) without just cause shown by him, refuses or neglects to-
    - (i) furnish, produce or make available any information, documents or things;
    - (ii) reply to or answer truly and fully, any questions put to him ...As and when required in terms of this Act ... shall be guilty of an offence ...
3. **SARS will, under no circumstances, issue a Tax Clearance Certificate unless this form is completed in full.**
4. Your Tax Clearance Certificate will only be issued on presentation of your South African Identity Document or Passport (Foreigners only) as applicable.

## BIDDER'S DISCLOSURE

**1. PURPOSE OF THE FORM**

Any person (natural or juristic) may make an offer or offers in terms of this invitation to bid. In line with the principles of transparency, accountability, impartiality, and ethics as enshrined in the Constitution of the Republic of South Africa and further expressed in various pieces of legislation, it is required for the bidder to make this declaration in respect of the details required hereunder.

Where a person/s are listed in the Register for Tender Defaulters and / or the List of Restricted Suppliers, that person will automatically be disqualified from the bid process.

**2. Bidder's declaration**

2.1 Is the bidder, or any of its directors / trustees / shareholders / members / partners or any person having a controlling interest<sup>1</sup> in the enterprise, employed by the state? **YES/NO**

2.1.1 If so, furnish particulars of the names, individual identity numbers, and, if applicable, state employee numbers of sole proprietor/ directors / trustees / shareholders / members/ partners or any person having a controlling interest in the enterprise, in table below.

| Full Name | Identity Number | Name of State institution |
|-----------|-----------------|---------------------------|
|           |                 |                           |
|           |                 |                           |
|           |                 |                           |
|           |                 |                           |
|           |                 |                           |
|           |                 |                           |
|           |                 |                           |
|           |                 |                           |
|           |                 |                           |
|           |                 |                           |

2.2 Do you, or any person connected with the bidder, have a relationship

---

<sup>1</sup> the power, by one person or a group of persons holding the majority of the equity of an enterprise, alternatively, the person/s having the deciding vote or power to influence or to direct the course and decisions of the enterprise.

with any person who is employed by the procuring institution? **YES/NO**

2.2.1 If so, furnish particulars:

.....  
.....

2.3 Does the bidder or any of its directors / trustees / shareholders / members / partners or any person having a controlling interest in the enterprise have any interest in any other related enterprise whether or not they are bidding for this contract? **YES/NO**

2.3.1 If so, furnish particulars:

.....  
.....

**3 DECLARATION**

I, \_\_\_\_\_ the \_\_\_\_\_ undersigned, (name)..... in submitting the accompanying bid, do hereby make the following statements that I certify to be true and complete in every respect:

- 3.1 I have read and I understand the contents of this disclosure;
- 3.2 I understand that the accompanying bid will be disqualified if this disclosure is found not to be true and complete in every respect;
- 3.3 The bidder has arrived at the accompanying bid independently from, and without consultation, communication, agreement or arrangement with any competitor. However, communication between partners in a joint venture or consortium<sup>2</sup> will not be construed as collusive bidding.
- 3.4 In addition, there have been no consultations, communications, agreements or arrangements with any competitor regarding the quality, quantity, specifications, prices, including methods, factors or formulas used to calculate prices, market allocation, the intention or decision to submit or not to submit the bid, bidding with the intention not to win the bid and conditions or delivery particulars of the products or services to which this bid invitation relates.
- 3.4 The terms of the accompanying bid have not been, and will not be, disclosed by the bidder, directly or indirectly, to any competitor, prior to the date and time of the official bid opening or of the awarding of the contract.
- 3.5 There have been no consultations, communications, agreements or arrangements made by the bidder with any official of the procuring

<sup>2</sup> Joint venture or Consortium means an association of persons for the purpose of combining their expertise, property, capital, efforts, skill and knowledge in an activity for the execution of a contract.

institution in relation to this procurement process prior to and during the bidding process except to provide clarification on the bid submitted where so required by the institution; and the bidder was not involved in the drafting of the specifications or terms of reference for this bid.

- 3.6 I am aware that, in addition and without prejudice to any other remedy provided to combat any restrictive practices related to bids and contracts, bids that are suspicious will be reported to the Competition Commission for investigation and possible imposition of administrative penalties in terms of section 59 of the Competition Act No 89 of 1998 and or may be reported to the National Prosecuting Authority (NPA) for criminal investigation and or may be restricted from conducting business with the public sector for a period not exceeding ten (10) years in terms of the Prevention and Combating of Corrupt Activities Act No 12 of 2004 or any other applicable legislation.

I CERTIFY THAT THE INFORMATION FURNISHED IN PARAGRAPHS 1, 2 and 3 ABOVE IS CORRECT.

I ACCEPT THAT THE STATE MAY REJECT THE BID OR ACT AGAINST ME IN TERMS OF PARAGRAPH 6 OF PFMA SCM INSTRUCTION 03 OF 2021/22 ON PREVENTING AND COMBATING ABUSE IN THE SUPPLY CHAIN MANAGEMENT SYSTEM SHOULD THIS DECLARATION PROVE TO BE FALSE.

.....  
Signature

.....  
Date

.....  
Position

.....  
Name of bidder

**PREFERENCE POINTS CLAIM FORM IN TERMS OF THE PREFERENTIAL  
PROCUREMENT REGULATIONS 2022**

This preference form must form part of all tenders invited. It contains general information and serves as a claim form for preference points for specific goals.

**NB: BEFORE COMPLETING THIS FORM, TENDERERS MUST STUDY THE GENERAL CONDITIONS, DEFINITIONS AND DIRECTIVES APPLICABLE IN RESPECT OF THE TENDER AND PREFERENTIAL PROCUREMENT REGULATIONS, 2022**

**1. GENERAL CONDITIONS**

1.1 The following preference point systems are applicable to invitations to tender:

- the 80/20 system for requirements with a Rand value of up to R50 000 000 (all applicable taxes included); and

**1.2 To be completed by the organ of state**

- a) The applicable preference point system for this tender is the 80/20 preference point system.
- b) The 80/20 preference point system will be applicable in this tender. The lowest/highest acceptable tender will be used to determine the accurate system once tenders are received.

1.3 Points for this tender (even in the case of a tender for income-generating contracts) shall be awarded for:

- (a) Price; and
- (b) Specific Goals.

**1.4 To be completed by the organ of state:**

The maximum points for this tender are allocated as follows:

|  | POINTS |
|--|--------|
| <b>PRICE</b>                                     | 80     |
| <b>SPECIFIC GOALS</b>                            | 20     |
| <b>Total points for Price and SPECIFIC GOALS</b> | 100    |

1.5 Failure on the part of a tenderer to submit proof or documentation required in terms of this tender to claim points for specific goals with the tender, will be interpreted to mean that preference points for specific goals are not claimed.

**RIVER ABSTRACTION PUMP STATION WITH WATER TREATMENT PLANT FOR INKANYEZI  
POULTRY FARM IN CALM, GERT SIBANDE DISTRICT**

---

- 1.6 The organ of state reserves the right to require of a tenderer, either before a tender is adjudicated or at any time subsequently, to substantiate any claim in regard to preferences, in any manner required by the organ of state.

**2. DEFINITIONS**

- (a) **“tender”** means a written offer in the form determined by an organ of state in response to an invitation to provide goods or services through price quotations, competitive tendering process or any other method envisaged in legislation;
- (b) **“price”** means an amount of money tendered for goods or services, and includes all applicable taxes less all unconditional discounts;
- (c) **“rand value”** means the total estimated value of a contract in Rand, calculated at the time of bid invitation, and includes all applicable taxes;
- (d) **“tender for income-generating contracts”** means a written offer in the form determined by an organ of state in response to an invitation for the origination of income-generating contracts through any method envisaged in legislation that will result in a legal agreement between the organ of state and a third party that produces revenue for the organ of state, and includes, but is not limited to, leasing and disposal of assets and concession contracts, excluding direct sales and disposal of assets through public auctions; and
- (e) **“the Act”** means the Preferential Procurement Policy Framework Act, 2000 (Act No. 5 of 2000).

**3. FORMULAE FOR PROCUREMENT OF GOODS AND SERVICES**

**3.1. POINTS AWARDED FOR PRICE**

**3.1.1 THE 80/20 PREFERENCE POINT SYSTEMS**

A maximum of 80 points is allocated for price on the following basis:

**80/20**

$$Ps = 80 \left( 1 - \frac{Pt - Pmin}{Pmin} \right)$$

Where

- Ps = Points scored for price of tender under consideration
- Pt = Price of tender under consideration
- Pmin = Price of lowest acceptable tender

3.2. FORMULAE FOR DISPOSAL OR LEASING OF STATE ASSETS AND INCOME  
GENERATING PROCUREMENT

3.2.1. POINTS AWARDED FOR PRICE

A maximum of 80 or 90 points is allocated for price on the following basis:

**80/20**

$$Ps = 80 \left( 1 + \frac{Pt - Pmax}{Pmax} \right)$$

Where

- Ps = Points scored for price of tender under consideration  
Pt = Price of tender under consideration  
Pmax = Price of highest acceptable tender

4. POINTS AWARDED FOR SPECIFIC GOALS

4.1. In terms of Regulation 4(2); 5(2); 6(2) and 7(2) of the Preferential Procurement Regulations, preference points must be awarded for specific goals stated in the tender. For the purposes of this tender the tenderer will be allocated points based on the goals stated in table 1 below as may be supported by proof/ documentation stated in the conditions of this tender:

4.2. In cases where organs of state intend to use Regulation 3(2) of the Regulations, which states that, if it is unclear whether the 80/20 or 90/10 preference point system applies, an organ of state must, in the tender documents, stipulate in the case of—

- (a) an invitation for tender for income-generating contracts, that either the 80/20 preference point system will apply and that the highest acceptable tender will be used to determine the applicable preference point system; or  
(b) any other invitation for tender, that either the 80/20 preference point system will apply and that the lowest acceptable tender will be used to determine the applicable preference point system,

then the organ of state must indicate the points allocated for specific goals for both the 90/10 and 80/20 preference point system.

**Table 1: Specific goals for the tender and points claimed are indicated per the table below.**

***Note to tenderers: The tenderer must indicate how they claim points for each preference point system.)***

**RIVER ABSTRACTION PUMP STATION WITH WATER TREATMENT PLANT FOR INKANYEZI POULTRY FARM IN CALM, GERT SIBANDE DISTRICT**

| The specific goals allocated points in terms of this tender  | Number of points allocated (80/20 system) (To be completed by the organ of state)  | Number of points claimed (80/20 system) (To be completed by the tenderer) |
|--|--|---|
| An Enterprise owned by black people  | 4  |   |
| An Enterprise owned by youth (35 years or younger)   | 2  |   |
| An Enterprise owned by women   | 2  |   |
| An Enterprise owned by people with a disability  | 4  |   |
| An Enterprise owned by Military Veterans   | 4  |   |
| <p>Promotion of South African Owned companies through the promotion of local manufacturers- local production and content</p> <p><b>Local production and content designated items and designated percentage required to claim preference points:</b></p> <ul style="list-style-type: none"> <li>• Cement – 100%</li> <li>• Polyvinyl chloride (PVC) pipes – 100%</li> <li>• Plastic Pipes (PVC, HDPE, PE) – 100%</li> <li>• Polypropylene (PP) pipes – 100%</li> <li>• Valves and actuators – 70%</li> <li>• Electrical cables – 90%</li> <li>• Transformers and shunt reactors – 90%</li> <li>• Steel Products and Components for Construction – 100%</li> </ul> | <p style="text-align: center;">4</p> <p style="text-align: center;">NB: (Points are allocated only when the bidder meets the designated percentage for all listed items)</p> |   |

**DECLARATION WITH REGARD TO COMPANY/FIRM**

- 4.3. Name of company/firm.....
- 4.4. Company registration number: .....
- 4.5. TYPE OF COMPANY/ FIRM

**RIVER ABSTRACTION PUMP STATION WITH WATER TREATMENT PLANT FOR INKANYEZI  
POULTRY FARM IN CALM, GERT SIBANDE DISTRICT**

---

- Partnership/Joint Venture / Consortium
- One-person business/sole propriety
- Close corporation
- Public Company
- Personal Liability Company
- (Pty) Limited
- Non-Profit Company
- State Owned Company

[TICK APPLICABLE BOX]

4.6. I, the undersigned, who is duly authorised to do so on behalf of the company/firm, certify that the points claimed, based on the specific goals as advised in the tender, qualifies the company/ firm for the preference(s) shown and I acknowledge that:

- i) The information furnished is true and correct;
- ii) The preference points claimed are in accordance with the General Conditions as indicated in paragraph 1 of this form;
- iii) In the event of a contract being awarded as a result of points claimed as shown in paragraphs 1.4 and 4.2, the contractor may be required to furnish documentary proof to the satisfaction of the organ of state that the claims are correct;
- iv) If the specific goals have been claimed or obtained on a fraudulent basis or any of the conditions of contract have not been fulfilled, the organ of state may, in addition to any other remedy it may have –
  - (a) disqualify the person from the tendering process;
  - (b) recover costs, losses or damages it has incurred or suffered as a result of that person's conduct;
  - (c) cancel the contract and claim any damages which it has suffered as a result of having to make less favourable arrangements due to such cancellation;
  - (d) recommend that the tenderer or contractor, its shareholders and directors, or only the shareholders and directors who acted on a fraudulent basis, be restricted from obtaining business from any organ of state for a period not exceeding 10 years, after the *audi alteram partem* (hear the other side) rule has been applied; and
  - (e) forward the matter for criminal prosecution, if deemed necessary.

|                                    |       |
|------------------------------------|-------|
| .....                              |       |
| <b>SIGNATURE(S) OF TENDERER(S)</b> |       |
| <b>SURNAME AND NAME:</b>           | ..... |
| <b>DATE:</b>                       | ..... |
| <b>ADDRESS:</b>                    | ..... |
|                                    | ..... |
|                                    | ..... |
|                                    | ..... |

## DECLARATION CERTIFICATE FOR LOCAL PRODUCTION AND CONTENT FOR DESIGNATED SECTORS

This Standard Bidding Document (SBD) must form part of all bids invited. It contains general information and serves as a declaration form for local content (local production and local content are used interchangeably).

Before completing this declaration, bidders must study the General Conditions, Definitions, Directives applicable in respect of Local Content as prescribed in the Preferential Procurement Regulations, 2017, the South African Bureau of Standards (SABS) approved technical specification number SATS 1286:2011 (Edition 1) and the Guidance on the Calculation of Local Content together with the Local Content Declaration Templates [Annex C (Local Content Declaration: Summary Schedule), D (Imported Content Declaration: Supporting Schedule to Annex C) and E (Local Content Declaration: Supporting Schedule to Annex C)].

### 1. General Conditions

- 1.1. Preferential Procurement Regulations, 2017 (Regulation 8) make provision for the promotion of local production and content.
- 1.2. Regulation 8.(2) prescribes that in the case of designated sectors, organs of state must advertise such tenders with the specific bidding condition that only locally produced or manufactured goods, with a stipulated minimum threshold for local production and content will be considered.
- 1.3. Where necessary, for tenders referred to in paragraph 1.2 above, a two stage bidding process may be followed, where the first stage involves a minimum threshold for local production and content and the second stage price and B-BBEE.
- 1.4. A person awarded a contract in relation to a designated sector, may not sub-contract in such a manner that the local production and content of the overall value of the contract is reduced to below the stipulated minimum threshold.
- 1.5. The local content (LC) expressed as a percentage of the bid price must be calculated in accordance with the SABS approved technical specification number SATS 1286: 2011 as follows:

$$LC = [1 - x / y] * 100$$

Where

- x is the imported content in Rand  
y is the bid price in Rand excluding value added tax (VAT)

Prices referred to in the determination of x must be converted to Rand (ZAR) by using the exchange rate published by South African Reserve Bank (SARB) on the date of advertisement of the bid as indicated in paragraph 3.1 below.

**The SABS approved technical specification number SATS 1286:2011 is accessible on [http://www.thedti.gov.za/industrial development/ip.jsp](http://www.thedti.gov.za/industrial%20development/ip.jsp) at no cost.**

1.6. A bid may be disqualified if this Declaration Certificate and the Annex C (Local Content Declaration: Summary Schedule) are not submitted as part of the bid documentation;

2. The stipulated minimum threshold(s) for local production and content (refer to Annex A of SATS 1286:2011) for this bid is/are as follows:

| <u>Description of services, works or goods</u> | <u>Stipulated minimum threshold</u> |
|--|-------------------------------------|
| _____  | _____ %                             |
| _____  | _____ %                             |
| _____  | _____ %                             |

3. Does any portion of the goods or services offered have any imported content?

(Tick applicable box)

|     |                          |    |                          |
|-----|--------------------------|----|--------------------------|
| YES | <input type="checkbox"/> | NO | <input type="checkbox"/> |
|-----|--------------------------|----|--------------------------|

3.1 If yes, the rate(s) of exchange to be used in this bid to calculate the local content as prescribed in paragraph 1.5 of the general conditions must be the rate(s) published by SARB for the specific currency on the date of advertisement of the bid.

The relevant rates of exchange information is accessible on [www.resbank.co.za](http://www.resbank.co.za)

Indicate the rate(s) of exchange against the appropriate currency in the table below (refer to Annex A of SATS 1286:2011):

| <b>Currency</b> | <b>Rates of exchange</b> |
|-----------------|--------------------------|
| US Dollar       |                          |
| Pound Sterling  |                          |
| Euro            |                          |
| Yen             |                          |
| Other           |                          |

NB: Bidders must submit proof of the SARB rate (s) of exchange used.

4. Where, after the award of a bid, challenges are experienced in meeting the stipulated minimum threshold for local content the dti must be informed accordingly in order for the dti to verify and in consultation with the AO/AA provide directives in this regard.

**LOCAL CONTENT DECLARATION**  
**(REFER TO ANNEX B OF SATS 1286:2011)**

**LOCAL CONTENT DECLARATION BY CHIEF FINANCIAL OFFICER OR OTHER LEGALLY RESPONSIBLE PERSON NOMINATED IN WRITING BY THE CHIEF EXECUTIVE OR SENIOR MEMBER/PERSON WITH MANAGEMENT RESPONSIBILITY (CLOSE CORPORATION, PARTNERSHIP OR INDIVIDUAL)**

**IN RESPECT OF BID NO. ....**

**ISSUED BY: (Procurement Authority / Name of Institution):**  
.....

NB

- 1 The obligation to complete, duly sign and submit this declaration cannot be transferred to an external authorized representative, auditor or any other third party acting on behalf of the bidder.
- 2 Guidance on the Calculation of Local Content together with Local Content Declaration Templates (Annex C, D and E) is accessible on [http://www.thedti.gov.za/industrial\\_development/ip.isp](http://www.thedti.gov.za/industrial_development/ip.isp). Bidders should first complete Declaration D. After completing Declaration D, bidders should complete Declaration E and then consolidate the information on Declaration C. **Declaration C should be submitted with the bid documentation at the closing date and time of the bid in order to substantiate the declaration made in paragraph (c) below.** Declarations D and E should be kept by the bidders for verification purposes for a period of at least 5 years. The successful bidder is required to continuously update Declarations C, D and E with the actual values for the duration of the contract.

I, the undersigned, ..... (full names),  
do hereby declare, in my capacity as .....  
of .....(name of bidder  
entity), the following:

- (a) The facts contained herein are within my own personal knowledge.
- (b) I have satisfied myself that:
  - (i) the goods/services/works to be delivered in terms of the above-specified bid comply with the minimum local content requirements as specified in the bid, and as measured in terms of SATS 1286:2011; and
- (c) The local content percentage (%) indicated below has been calculated using the formula given in clause 3 of SATS 1286:2011, the rates of exchange indicated in paragraph 3.1 above and the information contained in Declaration D and E which has been consolidated in Declaration C:

|  |   |
|--|---|
| Bid price, excluding VAT (y)                                       | R |
| Imported content (x), as calculated in terms of SATS 1286:2011     | R |
| Stipulated minimum threshold for local content (paragraph 3 above) |   |
| Local content %, as calculated in terms of SATS 1286:2011          |   |

**If the bid is for more than one product, the local content percentages for each product contained in Declaration C shall be used instead of the table above.**  
**The local content percentages for each product has been calculated using the formula given in clause 3 of SATS 1286:2011, the rates of exchange indicated in paragraph 3.1 above and the information contained in Declaration D and E.**

- (d) I accept that the Procurement Authority / Institution has the right to request that the local content be verified in terms of the requirements of SATS 1286:2011.
- (e) I understand that the awarding of the bid is dependent on the accuracy of the information furnished in this application. I also understand that the submission of incorrect data, or data that are not verifiable as described in SATS 1286:2011, may result in the Procurement Authority / Institution imposing any or all of the remedies as provided for in Regulation 14 of the Preferential Procurement Regulations, 2017 promulgated under the Preferential Policy Framework Act (PPPFA), 2000 (Act No. 5 of 2000).

# **THE NATIONAL TREASURY**

**Republic of South Africa**



---

## **GOVERNMENT PROCUREMENT: GENERAL CONDITIONS OF CONTRACT**

**July 2010**

**GOVERNMENT PROCUREMENT**  
**GENERAL CONDITIONS OF CONTRACT**  
**July 2010**

**NOTES**

The purpose of this document is to:

- (i) Draw special attention to certain general conditions applicable to government bids, contracts and orders; and
- (ii) To ensure that clients be familiar with regard to the rights and obligations of all parties involved in doing business with government.

In this document words in the singular also mean in the plural and vice versa and words in the masculine also mean in the feminine and neuter.

- The General Conditions of Contract will form part of all bid documents and may not be amended.
- Special Conditions of Contract (SCC) relevant to a specific bid, should be compiled separately for every bid (if applicable) and will supplement the General Conditions of Contract. Whenever there is a conflict, the provisions in the SCC shall prevail.

## TABLE OF CLAUSES

1. Definitions
2. Application
3. General
4. Standards
5. Use of contract documents and information; inspection
6. Patent rights
7. Performance security
8. Inspections, tests and analysis
9. Packing
10. Delivery and documents
11. Insurance
12. Transportation
13. Incidental services
14. Spare parts
15. Warranty
16. Payment
17. Prices
18. Contract amendments
19. Assignment
20. Subcontracts
21. Delays in the supplier's performance
22. Penalties
23. Termination for default
24. Dumping and countervailing duties
25. Force Majeure
26. Termination for insolvency
27. Settlement of disputes
28. Limitation of liability
29. Governing language
30. Applicable law
31. Notices
32. Taxes and duties
33. National Industrial Participation Programme (NIPP)
34. Prohibition of restrictive practices

## General Conditions of Contract

### 1. Definitions

1. The following terms shall be interpreted as indicated:
  - 1.1 "Closing time" means the date and hour specified in the bidding documents for the receipt of bids.
  - 1.2 "Contract" means the written agreement entered into between the purchaser and the supplier, as recorded in the contract form signed by the parties, including all attachments and appendices thereto and all documents incorporated by reference therein.
  - 1.3 "Contract price" means the price payable to the supplier under the contract for the full and proper performance of his contractual obligations.
  - 1.4 "Corrupt practice" means the offering, giving, receiving, or soliciting of any thing of value to influence the action of a public official in the procurement process or in contract execution.
  - 1.5 "Countervailing duties" are imposed in cases where an enterprise abroad is subsidized by its government and encouraged to market its products internationally.
  - 1.6 "Country of origin" means the place where the goods were mined, grown or produced or from which the services are supplied. Goods are produced when, through manufacturing, processing or substantial and major assembly of components, a commercially recognized new product results that is substantially different in basic characteristics or in purpose or utility from its components.
  - 1.7 "Day" means calendar day.
  - 1.8 "Delivery" means delivery in compliance of the conditions of the contract or order.
  - 1.9 "Delivery ex stock" means immediate delivery directly from stock actually on hand.
  - 1.10 "Delivery into consignees store or to his site" means delivered and unloaded in the specified store or depot or on the specified site in compliance with the conditions of the contract or order, the supplier bearing all risks and charges involved until the supplies are so delivered and a valid receipt is obtained.
  - 1.11 "Dumping" occurs when a private enterprise abroad market its goods on own initiative in the RSA at lower prices than that of the country of origin and which have the potential to harm the local industries in the

RSA.

- 1.12 "Force majeure" means an event beyond the control of the supplier and not involving the supplier's fault or negligence and not foreseeable. Such events may include, but is not restricted to, acts of the purchaser in its sovereign capacity, wars or revolutions, fires, floods, epidemics, quarantine restrictions and freight embargoes.
- 1.13 "Fraudulent practice" means a misrepresentation of facts in order to influence a procurement process or the execution of a contract to the detriment of any bidder, and includes collusive practice among bidders (prior to or after bid submission) designed to establish bid prices at artificial non-competitive levels and to deprive the bidder of the benefits of free and open competition.
- 1.14 "GCC" means the General Conditions of Contract.
- 1.15 "Goods" means all of the equipment, machinery, and/or other materials that the supplier is required to supply to the purchaser under the contract.
- 1.16 "Imported content" means that portion of the bidding price represented by the cost of components, parts or materials which have been or are still to be imported (whether by the supplier or his subcontractors) and which costs are inclusive of the costs abroad, plus freight and other direct importation costs such as landing costs, dock dues, import duty, sales duty or other similar tax or duty at the South African place of entry as well as transportation and handling charges to the factory in the Republic where the supplies covered by the bid will be manufactured.
- 1.17 "Local content" means that portion of the bidding price which is not included in the imported content provided that local manufacture does take place.
- 1.18 "Manufacture" means the production of products in a factory using labour, materials, components and machinery and includes other related value-adding activities.
- 1.19 "Order" means an official written order issued for the supply of goods or works or the rendering of a service.
- 1.20 "Project site," where applicable, means the place indicated in bidding documents.
- 1.21 "Purchaser" means the organization purchasing the goods.
- 1.22 "Republic" means the Republic of South Africa.
- 1.23 "SCC" means the Special Conditions of Contract.
- 1.24 "Services" means those functional services ancillary to the supply of the goods, such as transportation and any other incidental services, such as installation, commissioning, provision of technical assistance, training, catering, gardening, security, maintenance and other such

obligations of the supplier covered under the contract.

1.25 "Written" or "in writing" means handwritten in ink or any form of electronic or mechanical writing.

## **2. Application**

2.1 These general conditions are applicable to all bids, contracts and orders including bids for functional and professional services, sales, hiring, letting and the granting or acquiring of rights, but excluding immovable property, unless otherwise indicated in the bidding documents.

2.2 Where applicable, special conditions of contract are also laid down to cover specific supplies, services or works.

2.3 Where such special conditions of contract are in conflict with these general conditions, the special conditions shall apply.

## **3. General**

3.1 Unless otherwise indicated in the bidding documents, the purchaser shall not be liable for any expense incurred in the preparation and submission of a bid. Where applicable a non-refundable fee for documents may be charged.

3.2 With certain exceptions, invitations to bid are only published in the Government Tender Bulletin. The Government Tender Bulletin may be obtained directly from the Government Printer, Private Bag X85, Pretoria 0001, or accessed electronically from [www.treasury.gov.za](http://www.treasury.gov.za)

## **4. Standards**

4.1 The goods supplied shall conform to the standards mentioned in the bidding documents and specifications.

## **5. Use of contract documents and information; inspection.**

5.1 The supplier shall not, without the purchaser's prior written consent, disclose the contract, or any provision thereof, or any specification, plan, drawing, pattern, sample, or information furnished by or on behalf of the purchaser in connection therewith, to any person other than a person employed by the supplier in the performance of the contract. Disclosure to any such employed person shall be made in confidence and shall extend only so far as may be necessary for purposes of such performance.

5.2 The supplier shall not, without the purchaser's prior written consent, make use of any document or information mentioned in GCC clause 5.1 except for purposes of performing the contract.

5.3 Any document, other than the contract itself mentioned in GCC clause 5.1 shall remain the property of the purchaser and shall be returned (all copies) to the purchaser on completion of the supplier's performance under the contract if so required by the purchaser.

5.4 The supplier shall permit the purchaser to inspect the supplier's records relating to the performance of the supplier and to have them audited by auditors appointed by the purchaser, if so required by the purchaser.

## **6. Patent rights**

6.1 The supplier shall indemnify the purchaser against all third-party claims of infringement of patent, trademark, or industrial design rights arising from use of the goods or any part thereof by the purchaser.

**7. Performance security**

- 7.1 Within thirty (30) days of receipt of the notification of contract award, the successful bidder shall furnish to the purchaser the performance security of the amount specified in SCC.
- 7.2 The proceeds of the performance security shall be payable to the purchaser as compensation for any loss resulting from the supplier's failure to complete his obligations under the contract.
- 7.3 The performance security shall be denominated in the currency of the contract, or in a freely convertible currency acceptable to the purchaser and shall be in one of the following forms:
- (a) a bank guarantee or an irrevocable letter of credit issued by a reputable bank located in the purchaser's country or abroad, acceptable to the purchaser, in the form provided in the bidding documents or another form acceptable to the purchaser; or
  - (b) a cashier's or certified cheque
- 7.4 The performance security will be discharged by the purchaser and returned to the supplier not later than thirty (30) days following the date of completion of the supplier's performance obligations under the contract, including any warranty obligations, unless otherwise specified in SCC.

**8. Inspections, tests and analyses**

- 8.1 All pre-bidding testing will be for the account of the bidder.
- 8.2 If it is a bid condition that supplies to be produced or services to be rendered should at any stage during production or execution or on completion be subject to inspection, the premises of the bidder or contractor shall be open, at all reasonable hours, for inspection by a representative of the Department or an organization acting on behalf of the Department.
- 8.3 If there are no inspection requirements indicated in the bidding documents and no mention is made in the contract, but during the contract period it is decided that inspections shall be carried out, the purchaser shall itself make the necessary arrangements, including payment arrangements with the testing authority concerned.
- 8.4 If the inspections, tests and analyses referred to in clauses 8.2 and 8.3 show the supplies to be in accordance with the contract requirements, the cost of the inspections, tests and analyses shall be defrayed by the purchaser.
- 8.5 Where the supplies or services referred to in clauses 8.2 and 8.3 do not comply with the contract requirements, irrespective of whether such supplies or services are accepted or not, the cost in connection with these inspections, tests or analyses shall be defrayed by the supplier.
- 8.6 Supplies and services which are referred to in clauses 8.2 and 8.3 and which do not comply with the contract requirements may be rejected.
- 8.7 Any contract supplies may on or after delivery be inspected, tested or

analyzed and may be rejected if found not to comply with the requirements of the contract. Such rejected supplies shall be held at the cost and risk of the supplier who shall, when called upon, remove them immediately at his own cost and forthwith substitute them with supplies which do comply with the requirements of the contract. Failing such removal the rejected supplies shall be returned at the suppliers cost and risk. Should the supplier fail to provide the substitute supplies forthwith, the purchaser may, without giving the supplier further opportunity to substitute the rejected supplies, purchase such supplies as may be necessary at the expense of the supplier.

8.8 The provisions of clauses 8.4 to 8.7 shall not prejudice the right of the purchaser to cancel the contract on account of a breach of the conditions thereof, or to act in terms of Clause 23 of GCC.

#### **9. Packing**

9.1 The supplier shall provide such packing of the goods as is required to prevent their damage or deterioration during transit to their final destination, as indicated in the contract. The packing shall be sufficient to withstand, without limitation, rough handling during transit and exposure to extreme temperatures, salt and precipitation during transit, and open storage. Packing, case size and weights shall take into consideration, where appropriate, the remoteness of the goods' final destination and the absence of heavy handling facilities at all points in transit.

9.2 The packing, marking, and documentation within and outside the packages shall comply strictly with such special requirements as shall be expressly provided for in the contract, including additional requirements, if any, specified in SCC, and in any subsequent instructions ordered by the purchaser.

#### **10. Delivery and documents**

10.1 Delivery of the goods shall be made by the supplier in accordance with the terms specified in the contract. The details of shipping and/or other documents to be furnished by the supplier are specified in SCC.

10.2 Documents to be submitted by the supplier are specified in SCC.

#### **11. Insurance**

11.1 The goods supplied under the contract shall be fully insured in a freely convertible currency against loss or damage incidental to manufacture or acquisition, transportation, storage and delivery in the manner specified in the SCC.

#### **12. Transportation**

12.1 Should a price other than an all-inclusive delivered price be required, this shall be specified in the SCC.

#### **13. Incidental services**

13.1 The supplier may be required to provide any or all of the following services, including additional services, if any, specified in SCC:

- (a) performance or supervision of on-site assembly and/or commissioning of the supplied goods;
- (b) furnishing of tools required for assembly and/or maintenance of the supplied goods;
- (c) furnishing of a detailed operations and maintenance manual for each appropriate unit of the supplied goods;

- (d) performance or supervision or maintenance and/or repair of the supplied goods, for a period of time agreed by the parties, provided that this service shall not relieve the supplier of any warranty obligations under this contract; and
- (e) training of the purchaser's personnel, at the supplier's plant and/or on-site, in assembly, start-up, operation, maintenance, and/or repair of the supplied goods.

13.2 Prices charged by the supplier for incidental services, if not included in the contract price for the goods, shall be agreed upon in advance by the parties and shall not exceed the prevailing rates charged to other parties by the supplier for similar services.

**14. Spare parts**

14.1 As specified in SCC, the supplier may be required to provide any or all of the following materials, notifications, and information pertaining to spare parts manufactured or distributed by the supplier:

- (a) such spare parts as the purchaser may elect to purchase from the supplier, provided that this election shall not relieve the supplier of any warranty obligations under the contract; and
- (b) in the event of termination of production of the spare parts:
  - (i) Advance notification to the purchaser of the pending termination, in sufficient time to permit the purchaser to procure needed requirements; and
  - (ii) following such termination, furnishing at no cost to the purchaser, the blueprints, drawings, and specifications of the spare parts, if requested.

**15. Warranty**

15.1 The supplier warrants that the goods supplied under the contract are new, unused, of the most recent or current models, and that they incorporate all recent improvements in design and materials unless provided otherwise in the contract. The supplier further warrants that all goods supplied under this contract shall have no defect, arising from design, materials, or workmanship (except when the design and/or material is required by the purchaser's specifications) or from any act or omission of the supplier, that may develop under normal use of the supplied goods in the conditions prevailing in the country of final destination.

15.2 This warranty shall remain valid for twelve (12) months after the goods, or any portion thereof as the case may be, have been delivered to and accepted at the final destination indicated in the contract, or for eighteen (18) months after the date of shipment from the port or place of loading in the source country, whichever period concludes earlier, unless specified otherwise in SCC.

15.3 The purchaser shall promptly notify the supplier in writing of any claims arising under this warranty.

15.4 Upon receipt of such notice, the supplier shall, within the period specified in SCC and with all reasonable speed, repair or replace the defective goods or parts thereof, without costs to the purchaser.

15.5 If the supplier, having been notified, fails to remedy the defect(s) within the period specified in SCC, the purchaser may proceed to take

such remedial action as may be necessary, at the supplier's risk and expense and without prejudice to any other rights which the purchaser may have against the supplier under the contract.

**16. Payment**

- 16.1 The method and conditions of payment to be made to the supplier under this contract shall be specified in SCC.
- 16.2 The supplier shall furnish the purchaser with an invoice accompanied by a copy of the delivery note and upon fulfillment of other obligations stipulated in the contract.
- 16.3 Payments shall be made promptly by the purchaser, but in no case later than thirty (30) days after submission of an invoice or claim by the supplier.
- 16.4 Payment will be made in Rand unless otherwise stipulated in SCC.

**17. Prices**

- 17.1 Prices charged by the supplier for goods delivered and services performed under the contract shall not vary from the prices quoted by the supplier in his bid, with the exception of any price adjustments authorized in SCC or in the purchaser's request for bid validity extension, as the case may be.

**18. Contract amendments**

- 18.1 No variation in or modification of the terms of the contract shall be made except by written amendment signed by the parties concerned.

**19. Assignment**

- 19.1 The supplier shall not assign, in whole or in part, its obligations to perform under the contract, except with the purchaser's prior written consent.

**20. Subcontracts**

- 20.1 The supplier shall notify the purchaser in writing of all subcontracts awarded under this contracts if not already specified in the bid. Such notification, in the original bid or later, shall not relieve the supplier from any liability or obligation under the contract.

**21. Delays in the supplier's performance**

- 21.1 Delivery of the goods and performance of services shall be made by the supplier in accordance with the time schedule prescribed by the purchaser in the contract.
- 21.2 If at any time during performance of the contract, the supplier or its subcontractor(s) should encounter conditions impeding timely delivery of the goods and performance of services, the supplier shall promptly notify the purchaser in writing of the fact of the delay, its likely duration and its cause(s). As soon as practicable after receipt of the supplier's notice, the purchaser shall evaluate the situation and may at his discretion extend the supplier's time for performance, with or without the imposition of penalties, in which case the extension shall be ratified by the parties by amendment of contract.
- 21.3 No provision in a contract shall be deemed to prohibit the obtaining of supplies or services from a national department, provincial department, or a local authority.
- 21.4 The right is reserved to procure outside of the contract small quantities or to have minor essential services executed if an emergency arises, the

supplier's point of supply is not situated at or near the place where the supplies are required, or the supplier's services are not readily available.

21.5 Except as provided under GCC Clause 25, a delay by the supplier in the performance of its delivery obligations shall render the supplier liable to the imposition of penalties, pursuant to GCC Clause 22, unless an extension of time is agreed upon pursuant to GCC Clause 21.2 without the application of penalties.

21.6 Upon any delay beyond the delivery period in the case of a supplies contract, the purchaser shall, without canceling the contract, be entitled to purchase supplies of a similar quality and up to the same quantity in substitution of the goods not supplied in conformity with the contract and to return any goods delivered later at the supplier's expense and risk, or to cancel the contract and buy such goods as may be required to complete the contract and without prejudice to his other rights, be entitled to claim damages from the supplier.

## **22. Penalties**

22.1 Subject to GCC Clause 25, if the supplier fails to deliver any or all of the goods or to perform the services within the period(s) specified in the contract, the purchaser shall, without prejudice to its other remedies under the contract, deduct from the contract price, as a penalty, a sum calculated on the delivered price of the delayed goods or unperformed services using the current prime interest rate calculated for each day of the delay until actual delivery or performance. The purchaser may also consider termination of the contract pursuant to GCC Clause 23.

## **23. Termination for default**

23.1 The purchaser, without prejudice to any other remedy for breach of contract, by written notice of default sent to the supplier, may terminate this contract in whole or in part:

- (a) if the supplier fails to deliver any or all of the goods within the period(s) specified in the contract, or within any extension thereof granted by the purchaser pursuant to GCC Clause 21.2;
- (b) if the Supplier fails to perform any other obligation(s) under the contract; or
- (c) if the supplier, in the judgment of the purchaser, has engaged in corrupt or fraudulent practices in competing for or in executing the contract.

23.2 In the event the purchaser terminates the contract in whole or in part, the purchaser may procure, upon such terms and in such manner as it deems appropriate, goods, works or services similar to those undelivered, and the supplier shall be liable to the purchaser for any excess costs for such similar goods, works or services. However, the supplier shall continue performance of the contract to the extent not terminated.

23.3 Where the purchaser terminates the contract in whole or in part, the purchaser may decide to impose a restriction penalty on the supplier by prohibiting such supplier from doing business with the public sector for a period not exceeding 10 years.

23.4 If a purchaser intends imposing a restriction on a supplier or any

person associated with the supplier, the supplier will be allowed a time period of not more than fourteen (14) days to provide reasons why the envisaged restriction should not be imposed. Should the supplier fail to respond within the stipulated fourteen (14) days the purchaser may regard the intended penalty as not objected against and may impose it on the supplier.

- 23.5 Any restriction imposed on any person by the Accounting Officer / Authority will, at the discretion of the Accounting Officer / Authority, also be applicable to any other enterprise or any partner, manager, director or other person who wholly or partly exercises or exercised or may exercise control over the enterprise of the first-mentioned person, and with which enterprise or person the first-mentioned person, is or was in the opinion of the Accounting Officer / Authority actively associated.
- 23.6 If a restriction is imposed, the purchaser must, within five (5) working days of such imposition, furnish the National Treasury, with the following information:
- (i) the name and address of the supplier and / or person restricted by the purchaser;
  - (ii) the date of commencement of the restriction
  - (iii) the period of restriction; and
  - (iv) the reasons for the restriction.

These details will be loaded in the National Treasury's central database of suppliers or persons prohibited from doing business with the public sector.

- 23.7 If a court of law convicts a person of an offence as contemplated in sections 12 or 13 of the Prevention and Combating of Corrupt Activities Act, No. 12 of 2004, the court may also rule that such person's name be endorsed on the Register for Tender Defaulters. When a person's name has been endorsed on the Register, the person will be prohibited from doing business with the public sector for a period not less than five years and not more than 10 years. The National Treasury is empowered to determine the period of restriction and each case will be dealt with on its own merits. According to section 32 of the Act the Register must be open to the public. The Register can be perused on the National Treasury website.

#### **24. Anti-dumping and countervailing duties and rights**

- 24.1 When, after the date of bid, provisional payments are required, or anti-dumping or countervailing duties are imposed, or the amount of a provisional payment or anti-dumping or countervailing right is increased in respect of any dumped or subsidized import, the State is not liable for any amount so required or imposed, or for the amount of any such increase. When, after the said date, such a provisional payment is no longer required or any such anti-dumping or countervailing right is abolished, or where the amount of such provisional payment or any such right is reduced, any such favourable difference shall on demand be paid forthwith by the contractor to the State or the State may deduct such amounts from moneys (if any) which may otherwise be due to the contractor in regard to supplies or services which he delivered or rendered, or is to deliver or render in terms of the contract or any other contract or any other amount which

may be due to him

**25. Force Majeure**

25.1 Notwithstanding the provisions of GCC Clauses 22 and 23, the supplier shall not be liable for forfeiture of its performance security, damages, or termination for default if and to the extent that his delay in performance or other failure to perform his obligations under the contract is the result of an event of force majeure.

25.2 If a force majeure situation arises, the supplier shall promptly notify the purchaser in writing of such condition and the cause thereof. Unless otherwise directed by the purchaser in writing, the supplier shall continue to perform its obligations under the contract as far as is reasonably practical, and shall seek all reasonable alternative means for performance not prevented by the force majeure event.

**26. Termination for insolvency**

26.1 The purchaser may at any time terminate the contract by giving written notice to the supplier if the supplier becomes bankrupt or otherwise insolvent. In this event, termination will be without compensation to the supplier, provided that such termination will not prejudice or affect any right of action or remedy which has accrued or will accrue thereafter to the purchaser.

**27. Settlement of Disputes**

27.1 If any dispute or difference of any kind whatsoever arises between the purchaser and the supplier in connection with or arising out of the contract, the parties shall make every effort to resolve amicably such dispute or difference by mutual consultation.

27.2 If, after thirty (30) days, the parties have failed to resolve their dispute or difference by such mutual consultation, then either the purchaser or the supplier may give notice to the other party of his intention to commence with mediation. No mediation in respect of this matter may be commenced unless such notice is given to the other party.

27.3 Should it not be possible to settle a dispute by means of mediation, it may be settled in a South African court of law.

27.4 Mediation proceedings shall be conducted in accordance with the rules of procedure specified in the SCC.

27.5 Notwithstanding any reference to mediation and/or court proceedings herein,

- (a) the parties shall continue to perform their respective obligations under the contract unless they otherwise agree; and
- (b) the purchaser shall pay the supplier any monies due the supplier.

**28. Limitation of liability**

28.1 Except in cases of criminal negligence or willful misconduct, and in the case of infringement pursuant to Clause 6;

- (a) the supplier shall not be liable to the purchaser, whether in contract, tort, or otherwise, for any indirect or consequential loss or damage, loss of use, loss of production, or loss of profits or interest costs, provided that this exclusion shall not apply to any obligation of the supplier to pay penalties and/or damages to the purchaser; and

- (b) the aggregate liability of the supplier to the purchaser, whether under the contract, in tort or otherwise, shall not exceed the total contract price, provided that this limitation shall not apply to the cost of repairing or replacing defective equipment.
- 29. Governing language** 29.1 The contract shall be written in English. All correspondence and other documents pertaining to the contract that is exchanged by the parties shall also be written in English.
- 30. Applicable law** 30.1 The contract shall be interpreted in accordance with South African laws, unless otherwise specified in SCC.
- 31. Notices** 31.1 Every written acceptance of a bid shall be posted to the supplier concerned by registered or certified mail and any other notice to him shall be posted by ordinary mail to the address furnished in his bid or to the address notified later by him in writing and such posting shall be deemed to be proper service of such notice
- 31.2 The time mentioned in the contract documents for performing any act after such aforesaid notice has been given, shall be reckoned from the date of posting of such notice.
- 32. Taxes and duties** 32.1 A foreign supplier shall be entirely responsible for all taxes, stamp duties, license fees, and other such levies imposed outside the purchaser's country.
- 32.2 A local supplier shall be entirely responsible for all taxes, duties, license fees, etc., incurred until delivery of the contracted goods to the purchaser.
- 32.3 No contract shall be concluded with any bidder whose tax matters are not in order. Prior to the award of a bid the Department must be in possession of a tax clearance certificate, submitted by the bidder. This certificate must be an original issued by the South African Revenue Services.
- 33. National Industrial Participation Programme (NIP)** 33.1 The NIP Programme administered by the Department of Trade and Industry shall be applicable to all contracts that are subject to the NIP obligation.
- 34 Prohibition of Restrictive practices** 34.1 In terms of section 4 (1) (b) (iii) of the Competition Act No. 89 of 1998, as amended, an agreement between, or concerted practice by, firms, or a decision by an association of firms, is prohibited if it is between parties in a horizontal relationship and if a bidder (s) is / are or a contractor(s) was / were involved in collusive bidding (or bid rigging).
- 34.2 If a bidder(s) or contractor(s), based on reasonable grounds or evidence obtained by the purchaser, has / have engaged in the restrictive practice referred to above, the purchaser may refer the matter to the Competition Commission for investigation and possible imposition of administrative penalties as contemplated in the Competition Act No. 89 of 1998.

- 34.3 If a bidder(s) or contractor(s), has / have been found guilty by the Competition Commission of the restrictive practice referred to above, the purchaser may, in addition and without prejudice to any other remedy provided for, invalidate the bid(s) for such item(s) offered, and / or terminate the contract in whole or part, and / or restrict the bidder(s) or contractor(s) from conducting business with the public sector for a period not exceeding ten (10) years and / or claim damages from the bidder(s) or contractor(s) concerned.

Js General Conditions of Contract (revised July 2010)